

ENA-X Vector Network Analyzer

E5081A: 10 MHz to 44 GHz

Introduction

Characterizing components like power amplifiers or frequency converters is not easy. Requiring beyond just the standard S-parameter measurements, these devices additionally need high sensitivity and high-power performance characterization - as well as modulated signal tests such as EVM and ACPR. Juggling a network analyzer, signal analyzer, and switch matrix not only takes up valuable time, but also introduces even more measurement complexity error potential.

The E5081A ENA-X vector network analyzer (VNA) combines all your measurements into a single instrument, enabling system characterization with faster speeds and greater flexibility, at a lower cost. The built-in low noise receivers, and configurable test set combined with modulated signal measurements allows you to characterize high-performance components with a single connection. Easily perform RF measurements with software wizards to guide you through advanced wideband measurements.



Table of Contents

Definition	3
Dynamic Range.....	4
Corrected System Performance.....	9
Uncorrected System Performance	15
Test Port Output.....	21
Test Port Input.....	28
Noise Receiver Input (Port 1 and 2 with Option 0K1/0K2/0N1/0N2)	37
Dynamic Accuracy	39
Spectrum Analysis (with S96090xB).....	40
Modulation Distortion Analysis (with S96070xB)	53
Pulsed-RF Measurements (with S96024xB or S96025xB).....	58
Enhanced Time Domain Analysis with TDR (with S96011B)	64
General Information	65
Measurement Throughput.....	75
Front-Panel Jumpers.....	79
Test Set Block Diagrams.....	85
Literature Information	88
Web Resources.....	88
Confidently Covered by Keysight Services	89

Definition

Specification (spec)¹

Warranted performance. Specifications include guardbands to account for the expected statistical performance distribution, measurement uncertainties, and changes in performance due to environmental conditions. All specifications and characteristics apply over a $25\text{ °C} \pm 5\text{ °C}$ and relative humidity of 25 to 70% range (unless otherwise stated).

The following conditions must be met:

- Instrument has been turned on for 90 minutes with VNA application running.
- Instrument is within its calibration cycle.
- Instrument remains at a stable surrounding environment temperature (between 0 °C to 40 °C) for 60 minutes prior to turn-on.

Characteristics (char.)

A performance parameter that the product is expected to meet before it leaves the factory, but that is not verified in the field and is not covered by the product warranty. A characteristic includes the same guardbands as a specification.

Typical (typ.)

Expected performance of an average unit at a stable temperature between $25\text{ °C} \pm 5\text{ °C}$ for 60 minutes prior to turn-on and during operation; does not include guardbands. It is not covered by the product warranty. The instrument must be within its calibration cycle.

Nominal (nom.)

A general, descriptive term or design parameter. It is not tested, and not covered by the product warranty.

Supplemental Information

A performance parameter that is tested on sampled product during design validation. It does not include guardbands and is not covered by the product warranty.

Calibration

The process of measuring known standards to characterize an instrument's systematic (repeatable) errors.

Corrected (residual)

Indicates performance after error correction (calibration). It is determined by the quality of calibration standards and how well "known" they are, plus system repeatability, stability, and noise.

Uncorrected (raw)

Indicates instrument performance without error correction. The uncorrected performance affects the stability of a calibration.

1. For all tables in this data sheet, the specified performance at the exact frequency of a break is the better value of the two specifications at that frequency.

Dynamic Range

The specifications in this section apply to measurements made with the Keysight E5081A ENA-X vector network analyzer under the following conditions:

- 10 Hz IF bandwidth
- No averaging applied to data
- Does not include crosstalk effects

Table 1. System Dynamic Range at Test Port (dB) ¹

Specification

Option 2K5/2K6/4K5/4K6

Description	Port ² 1, 2	Port ^{2,3} 3, 4	S13, S14, S23, S24 ³	S31, S32, S41, S42 ³
10 MHz to 50 MHz ⁴	112	137	106	143
50 MHz to 100 MHz	112	140	106	146
100 MHz to 1 GHz	130	140	124	146
1 GHz to 2 GHz	146	140	140	146
2 GHz to 5 GHz	143	140	137	146
5 GHz to 6.5 GHz	143	140	136	147
6.5 GHz to 9 GHz	142	136	135	143
9 GHz to 10 GHz	141	133	133	141
10 GHz to 14 GHz	140	133	132	141
14 GHz to 15 GHz	140	130	132	138
15 GHz to 16 GHz	136	130	130	136
16 GHz to 17 GHz	136	126	127	135
17 GHz to 19 GHz	136	126	127	135
19 GHz to 20 GHz	133	126	127	132

Option 2N5/2N6/2N7/4N5/4N6/4N7

Description	Port ² 1, 2	Port ^{2,3} 3, 4	S13, S14, S23, S24 ³	S31, S32, S41, S42 ³
10 MHz to 50 MHz ⁴	112	137	106	143
50 MHz to 100 MHz	112	140	106	146
100 MHz to 1 GHz	130	140	124	146
1 GHz to 2 GHz	146	140	140	146
2 GHz to 5 GHz	143	140	137	146
5 GHz to 6.5 GHz	143	140	136	147
6.5 GHz to 8 GHz	142	138	136	144
8 GHz to 9 GHz	142	138	136	144
9 GHz to 10 GHz	141	137	136	142
10 GHz to 15 GHz	140	137	135	142
15 GHz to 17 GHz	136	137	133	140

Description	Port ² 1, 2	Port ^{2,3} 3, 4	S13, S14, S23, S24 ³	S31, S32, S41, S42 ³
17 GHz to 19 GHz	136	132	130	138
19 GHz to 20 GHz ⁵	133	132	130	135
20 GHz to 22 GHz	136	130	128	138
22 GHz to 24 GHz	135	130	128	137
24 GHz to 25 GHz	133	130	128	135
25 GHz to 27 GHz	131	127	126	132
27 GHz to 30 GHz	129	127	126	130
30 GHz to 32 GHz	127	122	121	128
32 GHz to 35 GHz	123	122	121	124
35 GHz to 36 GHz	119	122	118	123
36 GHz to 39 GHz	117	122	118	121
39 GHz to 40 GHz	116	122	118	120
40 GHz to 41 GHz	104	122	111	115
41 GHz to 42 GHz	93	122	111	104
42 GHz to 44 GHz	90	122	111	101

1. System dynamic range = source maximum output power minus receiver noise floor.

2. Either port can be used as the source port. Any other port can be used as the receiver port.

3. 4-port options only.

4. It may typically be degraded at 25 MHz.

5. Applies to the specification at 20 GHz.

Typical

Option 2K5/2K6/4K5/4K6

Description	Port ² 1, 2	Port ^{2,3} 3, 4	S13, S14, S23, S24 ³	S31, S32, S41, S42 ³
100 kHz to 300 kHz	71	126	66	130
300 kHz to 1 MHz	89	136	77	140
1 MHz to 10 MHz	100	141	87	145
10 MHz to 50 MHz ⁴	121	147	114	151
50 MHz to 100 MHz	121	150	114	154
100 MHz to 1 GHz	140	150	134	154
1 GHz to 2 GHz	153	150	145	154
2 GHz to 3 GHz	151	150	144	154
3 GHz to 4.5 GHz	151	149	144	153
4.5 GHz to 5 GHz	151	149	143	152
5 GHz to 6.5 GHz	151	148	142	154
6.5 GHz to 9 GHz	149	146	142	151
9 GHz to 10 GHz	148	142	140	148
10 GHz to 14 GHz	147	142	138	148
14 GHz to 15 GHz	147	140	138	146
15 GHz to 16 GHz	146	140	136	145
16 GHz to 17 GHz	146	137	133	145
17 GHz to 19 GHz	146	137	133	145
19 GHz to 20 GHz	141	137	133	141

Option 2N5/2N6/2N7/4N5/4N6/4N7

Description	Port ² 1, 2	Port ^{2,3} 3, 4	S13, S14, S23, S24 ³	S31, S32, S41, S42 ³
100 kHz to 300 kHz	71	106	60	116
300 kHz to 500 kHz	89	120	80	121
500 kHz to 1 MHz	89	130	80	131
1 MHz to 10 MHz	100	138	93	141
10 MHz to 50 MHz ⁴	121	147	114	150
50 MHz to 100 MHz	121	150	114	150
100 MHz to 200 MHz	140	150	134	150
200 MHz to 1 GHz	140	150	134	154
1 GHz to 2 GHz	153	150	145	154
2 GHz to 3 GHz	151	150	144	154
3 GHz to 5 GHz	151	150	144	152
5 GHz to 6.5 GHz	151	150	143	154
6.5 GHz to 8 GHz	149	150	143	151
8 GHz to 9 GHz	149	147	143	151
9 GHz to 10 GHz	148	147	143	149
10 GHz to 15 GHz	147	147	141	149
15 GHz to 16 GHz	146	147	139	148
16 GHz to 17 GHz	146	143	139	148
17 GHz to 19 GHz	146	143	137	146
19 GHz to 20 GHz	141	143	137	142
20 GHz to 22 GHz	144	143	137	145
22 GHz to 24 GHz	141	143	137	144
24 GHz to 25 GHz	139	141	134	142
25 GHz to 26 GHz	138	141	132	140
26 GHz to 27 GHz	138	137	132	140
27 GHz to 30 GHz	140	137	132	141
30 GHz to 32 GHz	138	137	130	138
32 GHz to 33 GHz	134	137	130	136
33 GHz to 35 GHz	133	137	130	134
35 GHz to 36 GHz	130	134	127	132
36 GHz to 37.5 GHz	128	134	127	130
37.5 GHz to 38 GHz	127	134	127	130
38 GHz to 39 GHz	127	134	124	130
39 GHz to 40 GHz	126	134	124	129
40 GHz to 41 GHz	119	132	119	123
41 GHz to 42 GHz	110	132	119	113
42 GHz to 43 GHz	105	132	119	113
43 GHz to 44 GHz	107	132	119	113

1. System dynamic range = source maximum output power minus receiver noise floor.

2. Either port can be used as the source port. Any other port can be used as the receiver port.

3. 4-port options only.

4. It may typically be degraded at 25 MHz.

Table 2. Extended Dynamic Range at Direct Receiver Access Input with port 1 and 2 (dB) ¹

Description	Specification	Typical
100 kHz to 300 kHz	--	157
300 kHz to 1 MHz	--	168
1 MHz to 10 MHz	--	169
10 MHz to 100 MHz ²	--	168
100 MHz to 1 GHz	--	167
1 GHz to 2 GHz	--	166
2 GHz to 5 GHz	--	164
5 GHz to 9 GHz	--	163
9 GHz to 10 GHz	--	161
10 GHz to 15 GHz	--	160
15 GHz to 19 GHz	--	158
19 GHz to 20 GHz	--	153
20 GHz to 22 GHz	--	155
22 GHz to 24 GHz	--	153
24 GHz to 25 GHz	--	152
25 GHz to 27 GHz	--	151
27 GHz to 32 GHz	--	150
32 GHz to 33 GHz	--	146
33 GHz to 35 GHz	--	144
35 GHz to 36 GHz	--	141
36 GHz to 37.5 GHz	--	139
37.5 GHz to 39 GHz	--	134
39 GHz to 40 GHz	--	133
40 GHz to 41 GHz	--	128
41 GHz to 42 GHz	--	123
42 GHz to 44 GHz	--	116

1. Extended dynamic range at direct receiver access input is defined as source maximum output power minus receiver noise floor using direct receiver access input.
2. It may typically be degraded at 25 MHz.

Table 3. Extended Dynamic Range at Test Port with Low Noise Path with Port 1 and 2 (dB) ^{1,2}

Description	Specification	Typical
100 kHz to 300 kHz	--	138
300 kHz to 1 MHz	--	145
1 MHz to 10 MHz	--	152
10 MHz to 100 MHz ³	--	168
100 MHz to 2 GHz	--	173
2 GHz to 6.5 GHz	--	171
6.5 GHz to 10 GHz	--	170
10 GHz to 15 GHz	--	169
15 GHz to 19 GHz	--	166
19 GHz to 20 GHz	--	162
20 GHz to 24 GHz	--	163
24 GHz to 27 GHz	--	162
27 GHz to 32 GHz	--	163
32 GHz to 33 GHz	--	159
33 GHz to 35 GHz	--	156
35 GHz to 36 GHz	--	153
36 GHz to 39 GHz	--	151
39 GHz to 40 GHz	--	150
40 GHz to 41 GHz	--	145
41 GHz to 42 GHz	--	136
42 GHz to 43 GHz	--	133
43 GHz to 44 GHz	--	134

1. Extended dynamic range at test port with low noise path is defined as source maximum output power minus receiver noise floor using the low noise path.
2. Full 2-port calibrated measurements are not supported with this configuration using the low noise path. Enhanced response calibrations are supported.
3. It may typically be degraded at 25 MHz

Table 4. Receiver Dynamic Range with Port 1 and 2 (dB) ¹

Description	Specification	Typical
100 kHz to 300 kHz	--	72
300 kHz to 1 MHz	--	83
1 MHz to 10 MHz	--	93
10 MHz to 100 MHz ²	--	114
100 MHz to 1 GHz	--	134
1 GHz to 2 GHz	--	145
2 GHz to 5 GHz	--	144
5 GHz to 10 GHz	--	143
10 GHz to 15 GHz	--	141
15 GHz to 20 GHz	--	136
20 GHz to 25 GHz	--	139
25 GHz to 26.5 GHz	--	137
26.5 GHz to 30 GHz	--	132
30 GHz to 35 GHz	--	130
35 GHz to 38 GHz	--	127
38 GHz to 40 GHz	--	126
40 GHz to 44 GHz	--	119

1. Receiver dynamic range is defined as the typical test port 0.15 dB compression minus the typical noise floor.

2. It may typically be degraded at 25 MHz.

Corrected System Performance

This section provides specifications for the corrected performance of 2-port E5081A ENA-X using Mechanical Calibration Kit or Electronic Calibration (ECal) Module. To determine transmission and reflection uncertainty curves with 4-port E5081A and other calibration kits, please download the Uncertainty Calculator from http://www.keysight.com/find/na_calculator to generate the curves for your specific calibration kit.

Measured with 10 Hz IF bandwidth, no averaging applied to data. Measurement uncertainty values are achieved when the instrument has been stored for 48 hours in a stable environment and has been on for 24 hours prior to calibration. The average environmental humidity for 24 hours before and after calibration must be in the 25% to 70% range and have less than 5% deviation. The environmental temperature must be within 23 °C ± 3 °C, with less than 1 °C deviation from the calibration temperature. The calibration is valid for 24 hours.

Table 5. E5081A Option 2K5/2K6 with 85052D Economy Mechanical Calibration Kit

Corrected error terms (dB) – Specifications

Description	10 MHz to 50 MHz	50 MHz to 500 MHz	500 MHz to 2 GHz	2 GHz to 8 GHz	8 GHz to 20 GHz
Directivity	42	42	42	38	36
Source match	37	37	37	31	28
Load match	42	42	42	38	36
Reflection tracking	± 0.003	± 0.003	± 0.003	± 0.004	± 0.008
Transmission tracking	± 0.024	± 0.024	± 0.038	± 0.01	± 0.208

Transmission uncertainty (magnitude and phase)

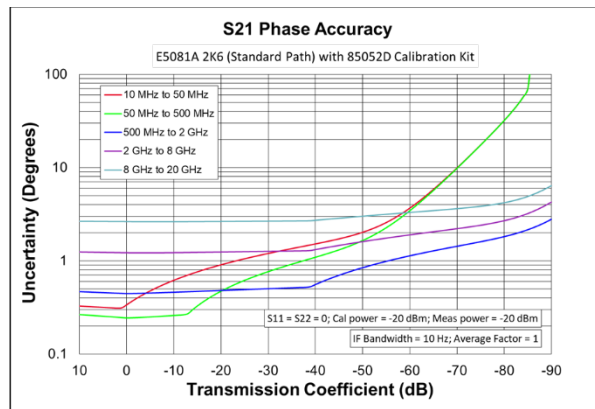
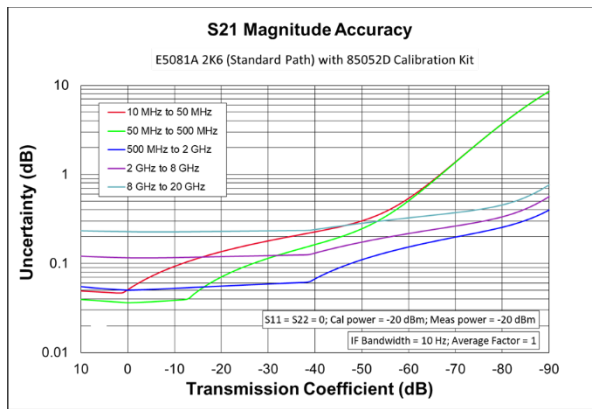

Reflection uncertainty (magnitude and phase)

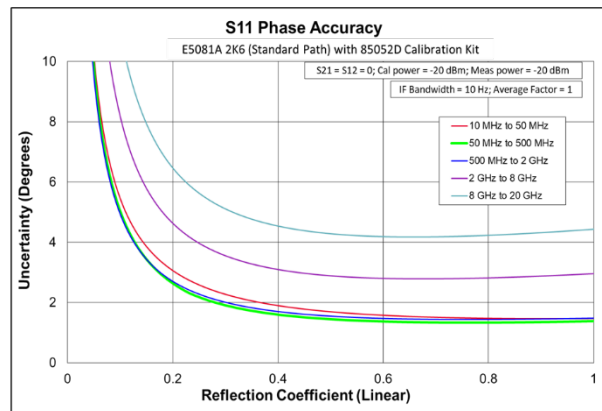
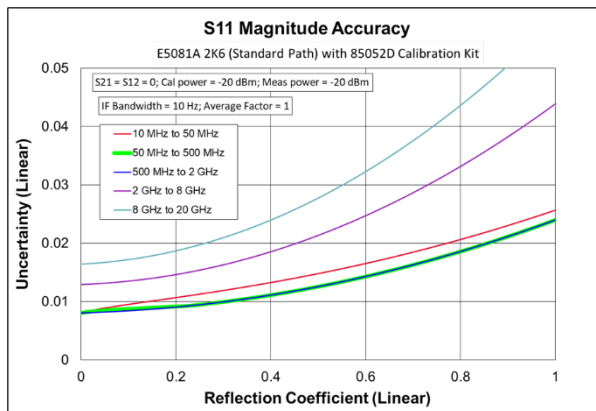
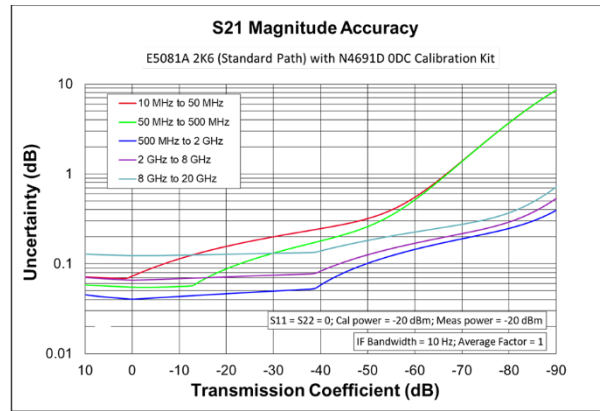
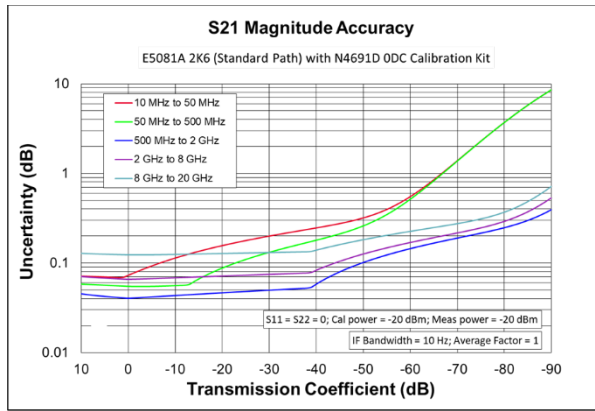

Table 6. E5081A Option 2K5/2K6 with N4691D Electronic Calibration (ECal) Module with Option 0DC

Corrected error terms (dB) – Specifications

Description	10 MHz to 50 MHz	50 MHz to 500 MHz	500 MHz to 2 GHz	2 GHz to 8 GHz	8 GHz to 20 GHz
Directivity	46	46	47	46	43
Source match	41	41	47	45	42
Load match	42	42	44	41	37
Reflection tracking	± 0.050	± 0.050	± 0.020	± 0.030	± 0.040
Transmission tracking	± 0.045	± 0.041	± 0.029	± 0.051	± 0.104

Transmission uncertainty (magnitude and phase)



Reflection uncertainty (magnitude and phase)

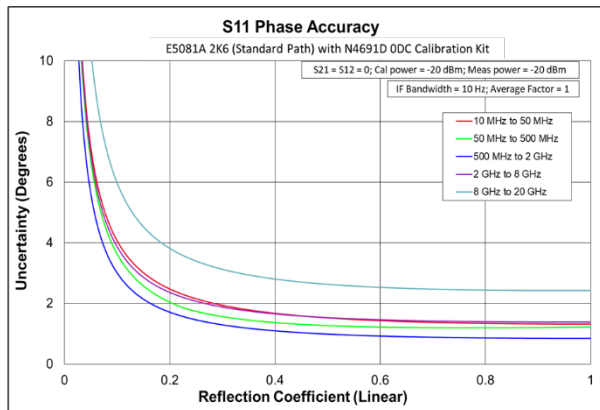
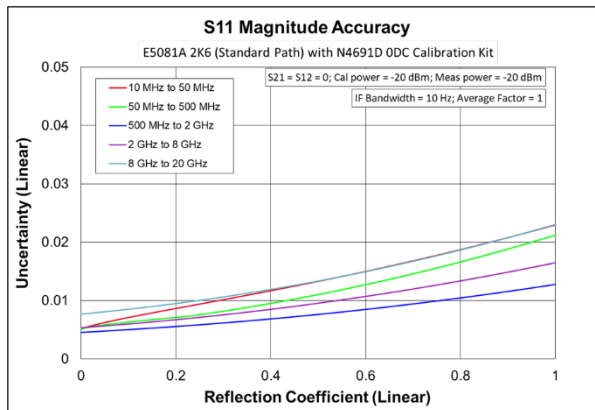
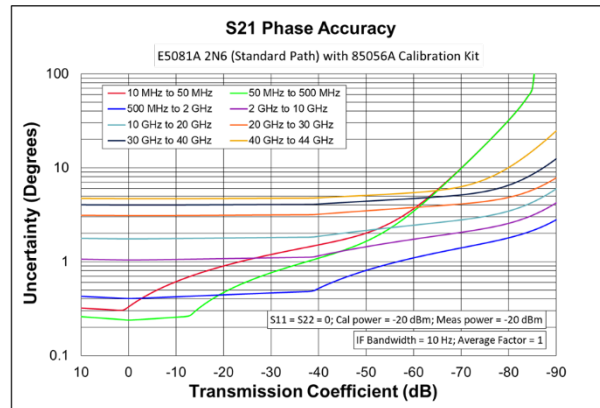
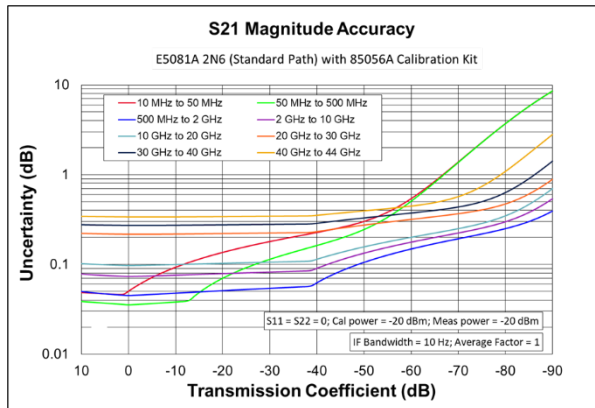

Table 7. E5081A Option 2N5/2N6/2N7 with 85056A Mechanical Calibration Kit

Corrected error terms (dB) – Specifications

Description	10 MHz to 50 MHz	50 MHz to 500 MHz	500 MHz to 2 GHz	2 GHz to 10 GHz	10 GHz to 20 GHz	20 GHz to 30 GHz	30 GHz to 40 GHz	40 GHz to 44 GHz
Directivity	42	42	42	42	42	38	38	36
Source match	41	41	41	38	38	33	33	31
Load match	42	42	42	42	41	37	37	35
Reflection tracking	± 0.001	± 0.001	± 0.001	± 0.008	± 0.008	± 0.020	± 0.020	± 0.027
Transmission tracking	± 0.023	± 0.023	± 0.032	± 0.058	± 0.082	± 0.197	± 0.25	± 0.314

Transmission uncertainty (magnitude and phase)



Reflection uncertainty (magnitude and phase)

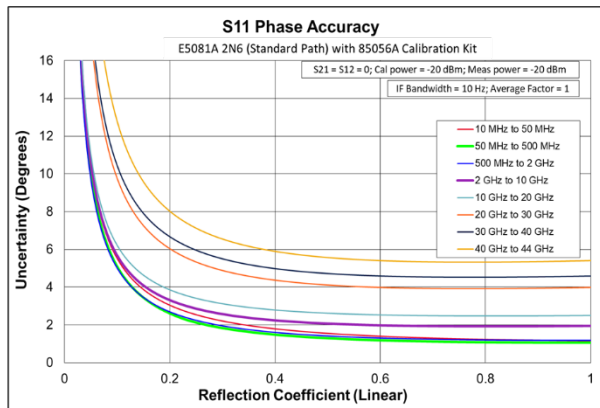
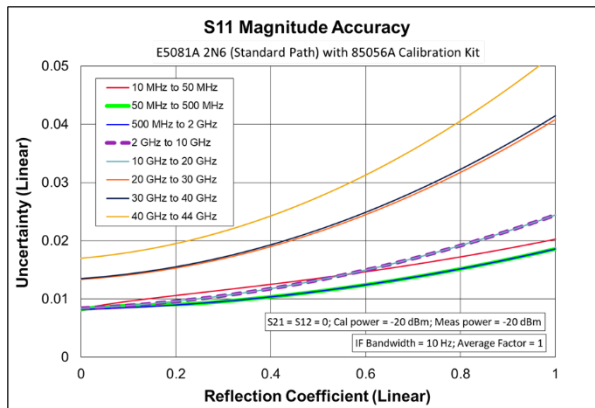
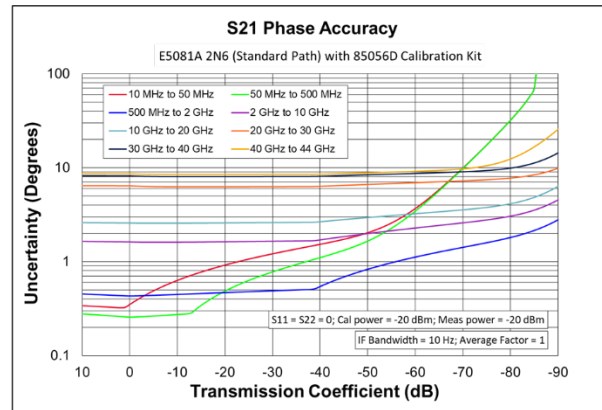
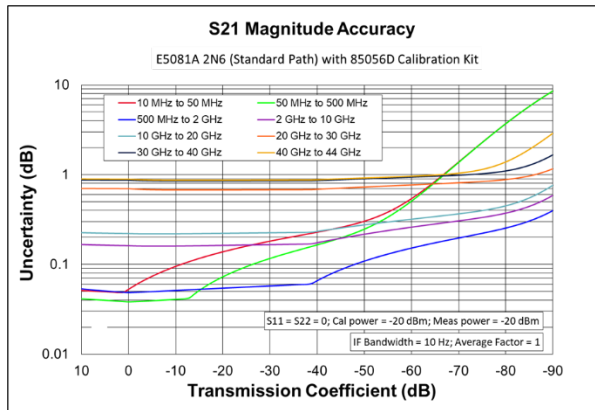

Table 8. E5081A Option 2N5/2N6/2N7 with 85056D Mechanical Calibration Kit

Corrected error terms (dB) – Specifications

Description	10 MHz to 50 MHz	50 MHz to 500 MHz	500 MHz to 2 GHz	2 GHz to 10 GHz	10 GHz to 20 GHz	20 GHz to 30 GHz	30 GHz to 40 GHz	40 GHz to 44 GHz
Directivity	42	42	42	34	34	26	26	26
Source match	40	40	40	30	30	23	23	23
Load match	42	42	42	33	33	25	25	25
Reflection tracking	± 0.002	± 0.002	± 0.002	± 0.029	± 0.029	± 0.079	± 0.079	± 0.075
Transmission tracking	± 0.025	± 0.025	± 0.036	± 0.142	± 0.202	± 0.651	± 0.821	± 0.843

Transmission uncertainty (magnitude and phase)



Reflection uncertainty (magnitude and phase)

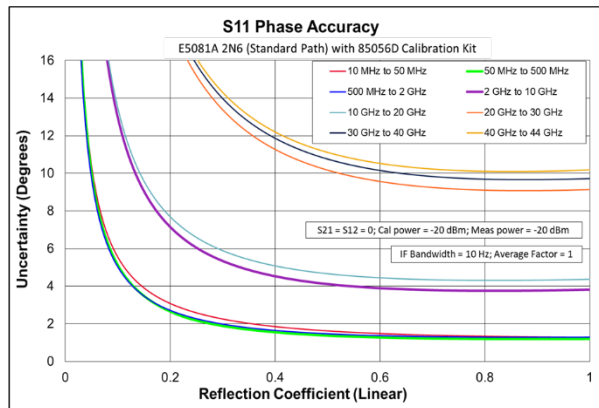
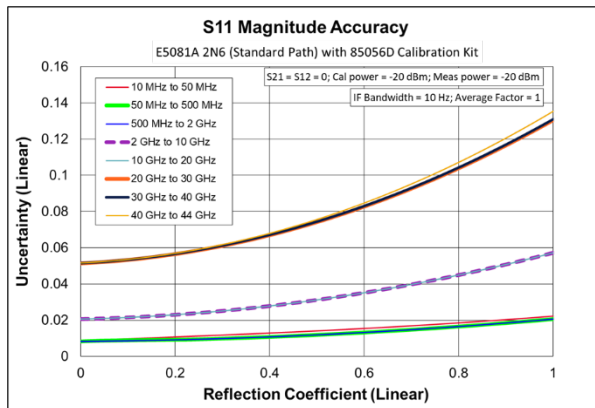
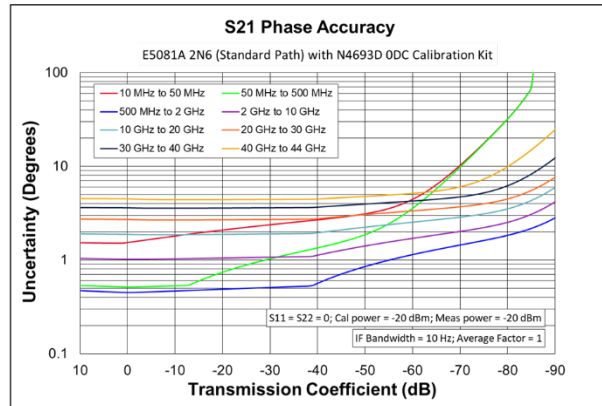
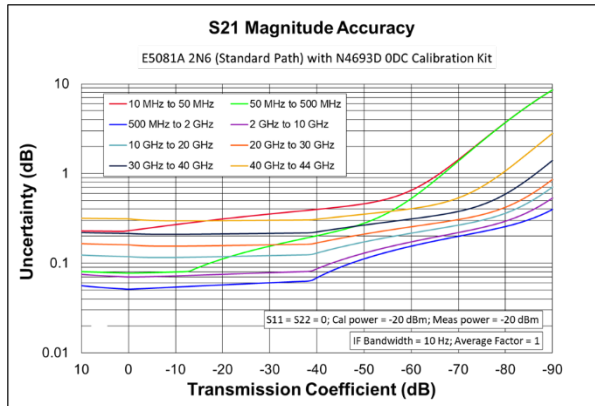

Table 9. E5081A Option 2N5/2N6/2N7 with N4693D Electronic Calibration (ECal) Module with Option 0DC

Corrected error terms (dB) – Specifications

Description	10 MHz to 50 MHz	50 MHz to 500 MHz	500 MHz to 2 GHz	2 GHz to 10 GHz	10 GHz to 20 GHz	20 GHz to 30 GHz	30 GHz to 40 GHz	40 GHz to 44 GHz
Directivity	40	40	46	47	44	38	38	34
Source match	38	44	46	42	37	35	35	32
Load match	33	37	42	44	39	34	33	29
Reflection tracking	± 0.050	± 0.050	± 0.030	± 0.040	± 0.050	± 0.060	± 0.060	± 0.080
Transmission tracking	± 0.201	± 0.065	± 0.038	± 0.054	± 0.097	± 0.133	± 0.185	± 0.271

Transmission uncertainty (magnitude and phase)



Reflection uncertainty (magnitude and phase)

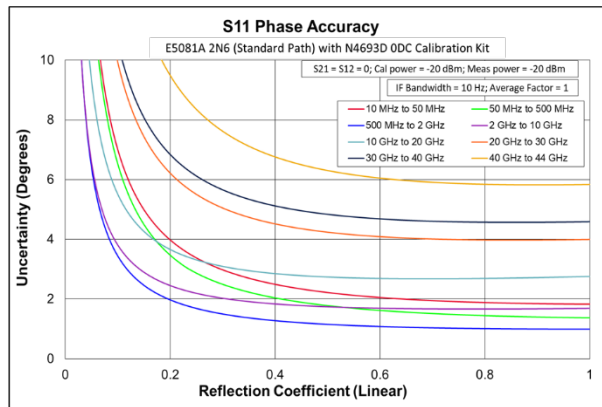
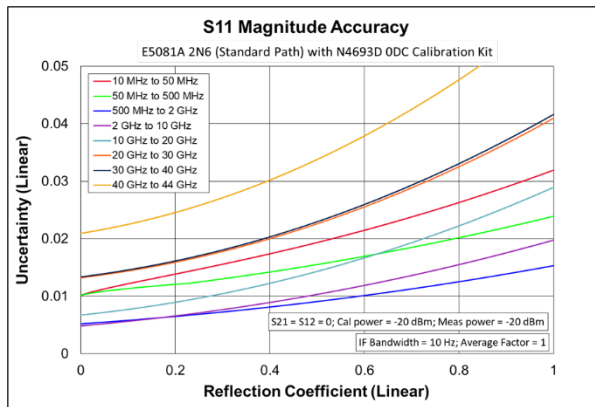

Uncorrected System Performance

Table 10. Uncorrected Error Terms (dB)^{1, 2} – Specification

Port 1 and 2 (Option 2K5/2K6/4K5/4K6)³

Description	Directivity	Source match	Load match	Transmission tracking	Reflection tracking	Crosstalk
10 MHz to 100 MHz	20	20	18	--	--	--
100 MHz to 500 MHz	25	25	18	--	--	--
500 MHz to 5 GHz	25	25	14	--	--	--
5 GHz to 10 GHz	20	20	11	--	--	--
10 GHz to 14 GHz	20	20	10	--	--	--
14 GHz to 20 GHz	20	20	7	--	--	--

Port 1 and 2 (Option 2N5/2N6/2N7/4N5/4N6/4N7)³

Description	Directivity	Source match	Load match	Transmission tracking	Reflection tracking	Crosstalk
10 MHz to 100 MHz	20	20	16	--	--	--
100 MHz to 500 MHz	25	25	16	--	--	--
500 MHz to 5 GHz	25	25	13	--	--	--
5 GHz to 10 GHz	20	20	10	--	--	--
10 GHz to 20 GHz	20	20	7	--	--	--
20 GHz to 25 GHz	14	15	7	--	--	--
25 GHz to 33 GHz	14	15	4	--	--	--
33 GHz to 40 GHz	14	15	2	--	--	--
40 GHz to 44 GHz	9	10	2	--	--	--

Port 3 and 4 (Option 4K5/4K6)³

Description	Directivity	Source match	Load match	Transmission tracking	Reflection tracking	Crosstalk
10 MHz to 2.5 GHz	25	25	16	--	--	--
2.5 GHz to 3 GHz	25	25	15	--	--	--
3 GHz to 6 GHz	25	25	11	--	--	--
6 GHz to 7 GHz	20	20	11	--	--	--
7 GHz to 10 GHz	20	20	10	--	--	--
10 GHz to 16 GHz	15	20	10	--	--	--
16 GHz to 17 GHz	15	20	8	--	--	--
17 GHz to 20 GHz	15	20	6	--	--	--

Port 3 and 4 (Option 4N5/4N6/4N7)³

Description	Directivity	Source match	Load match	Transmission tracking	Reflection tracking	Crosstalk
10 MHz to 1 GHz	25	25	16	--	--	--
1 GHz to 4 GHz	25	25	14	--	--	--
4 GHz to 6 GHz	25	25	12	--	--	--
6 GHz to 9 GHz	20	20	12	--	--	--
9 GHz to 10 GHz	20	20	11	--	--	--
10 GHz to 20 GHz	15	20	9	--	--	--
20 GHz to 25 GHz	15	20	8	--	--	--

Description	Directivity	Source match	Load match	Transmission tracking	Reflection tracking	Crosstalk
25 GHz to 27 GHz	15	20	7	--	--	--
27 GHz to 40 GHz	15	20	5	--	--	--
40 GHz to 44 GHz	15	20	6	--	--	--

1. Specifications apply to following conditions: Factory correction is turned on and gain coupling is turned on.
2. Instrument has been stored for a minimum of 24 hours in a stable environment before measurement.
3. Either port can be used as the source port. Any other port can be used as the receiver port.

Table 11. Uncorrected Error Terms (dB)¹ – Typical

Port 1 and 2 (Option 2K5/2K6/4K5/4K6)²

Description	Directivity	Source match	Load match	Transmission tracking	Reflection tracking	Crosstalk
10 MHz to 100 MHz	40	35	21	± 0.5	± 0.5	-121 ³
100 MHz to 500 MHz	40	35	21	± 0.5	± 0.5	-140
500 MHz to 1 GHz	50	50	18	± 0.2	± 0.2	-140
1 GHz to 2 GHz	50	50	18	± 0.2	± 0.2	-153
2 GHz to 5 GHz	50	50	18	± 0.2	± 0.2	-151
5 GHz to 6 GHz	45	40	14	± 0.2	± 0.2	-151
6 GHz to 6.5 GHz	45	40	14	± 0.2	± 0.2	-151
6.5 GHz to 9 GHz	45	40	14	± 0.2	± 0.2	-149
9 GHz to 10 GHz	45	40	14	± 0.2	± 0.2	-148
10 GHz to 15 GHz	30	35	9	± 0.3	± 0.3	-147
15 GHz to 19 GHz	30	35	9	± 0.3	± 0.3	-146
19 GHz to 20 GHz	30	35	9	± 0.3	± 0.3	-141

Port 1 and 2 (Option 2N5/2N6/2N7/4N5/4N6/4N7)²

Description	Directivity	Source match	Load match	Transmission tracking	Reflection tracking	Crosstalk
10 MHz to 100 MHz	40	35	19	± 0.5	± 0.5	-121 ³
100 MHz to 500 MHz	40	35	19	± 0.5	± 0.5	-140
500 MHz to 1 GHz	50	50	17	± 0.2	± 0.2	-140
1 GHz to 2 GHz	50	50	17	± 0.2	± 0.2	-153
2 GHz to 5 GHz	50	50	17	± 0.2	± 0.2	-151
5 GHz to 6 GHz	45	40	13	± 0.2	± 0.2	-151
6 GHz to 6.5 GHz	45	40	13	± 0.2	± 0.2	-151
6.5 GHz to 9 GHz	45	40	13	± 0.2	± 0.2	-149
9 GHz to 10 GHz	45	40	13	± 0.2	± 0.2	-148
10 GHz to 15 GHz	30	35	9	± 0.3	± 0.3	-147
15 GHz to 19 GHz	30	35	9	± 0.3	± 0.3	-146
19 GHz to 20 GHz	30	35	9	± 0.3	± 0.3	-141
20 GHz to 22 GHz	30	35	10	± 0.3	± 0.3	-144
22 GHz to 24 GHz	30	35	10	± 0.3	± 0.3	-141
24 GHz to 25 GHz	30	35	10	± 0.3	± 0.3	-139
25 GHz to 27 GHz	30	35	7	± 0.3	± 0.3	-138
27 GHz to 30 GHz	30	35	7	± 0.3	± 0.3	-140
30 GHz to 32 GHz	20	30	7	± 0.3	± 0.3	-138
32 GHz to 33 GHz	20	30	7	± 0.3	± 0.3	-134
33 GHz to 35 GHz	20	30	4	± 0.3	± 0.3	-133
35 GHz to 36 GHz	20	20	4	± 1.0	± 1.0	-130

Description	Directivity	Source match	Load match	Transmission tracking	Reflection tracking	Crosstalk
36 GHz to 37.5 GHz	20	20	4	± 1.0	± 1.0	-128
37.5 GHz to 39 GHz	20	20	4	± 1.0	± 1.0	-127
39 GHz to 40 GHz	20	20	4	± 1.0	± 1.0	-126
40 GHz to 41 GHz	20	20	4	± 1.5	± 1.5	-119
41 GHz to 42 GHz	20	20	4	± 1.5	± 1.5	-110
42 GHz to 43 GHz	20	20	4	± 1.5	± 1.5	-105
43 GHz to 44 GHz	20	20	4	± 1.5	± 1.5	-107

Port 3 and 4 (Option 4K5/4K6)²

Description	Directivity	Source match	Load match	Transmission tracking	Reflection tracking	Crosstalk
10 MHz to 50 MHz	40	40	23	± 0.2	± 0.2	-147 ³
50 MHz to 1.5 GHz	40	40	23	± 0.2	± 0.2	-150
1.5 GHz to 2.5 GHz	40	40	20	± 0.2	± 0.2	-150
2.5 GHz to 3 GHz	40	40	19	± 0.2	± 0.2	-150
3 GHz to 5 GHz	40	40	15	± 0.2	± 0.2	-149
5 GHz to 6 GHz	40	40	15	± 0.2	± 0.2	-148
6 GHz to 6.5 GHz	35	35	15	± 0.3	± 0.3	-148
6.5 GHz to 7 GHz	35	35	15	± 0.3	± 0.3	-146
7 GHz to 9 GHz	35	35	14	± 0.3	± 0.3	-146
9 GHz to 10 GHz	35	35	14	± 0.3	± 0.3	-142
10 GHz to 14 GHz	35	35	14	± 0.5	± 0.5	-142
14 GHz to 16 GHz	35	35	14	± 0.5	± 0.5	-140
16 GHz to 17 GHz	35	35	12	± 0.5	± 0.5	-137
17 GHz to 20 GHz	35	35	10	± 0.5	± 0.5	-137

Port 3 and 4 (Option 4N5/4N6/4N7)²

Description	Directivity	Source match	Load match	Transmission tracking	Reflection tracking	Crosstalk
10 MHz to 50 MHz	40	40	19	± 0.2	± 0.2	-147 ³
50 MHz to 1 GHz	40	40	19	± 0.2	± 0.2	-150
1 GHz to 4 GHz	40	40	17	± 0.2	± 0.2	-150
4 GHz to 6 GHz	40	40	15	± 0.2	± 0.2	-150
6 GHz to 8 GHz	35	35	15	± 0.3	± 0.3	-150
8 GHz to 9 GHz	35	35	15	± 0.3	± 0.3	-147
9 GHz to 10 GHz	35	35	14	± 0.3	± 0.3	-147
10 GHz to 16 GHz	35	35	11	± 0.3	± 0.3	-147
16 GHz to 20 GHz	35	35	11	± 0.3	± 0.3	-143
20 GHz to 24 GHz	25	25	10	± 0.3	± 0.3	-143
24 GHz to 25 GHz	25	25	10	± 0.3	± 0.3	-141
25 GHz to 26 GHz	25	25	9	± 0.3	± 0.3	-141
26 GHz to 27 GHz	25	25	9	± 0.3	± 0.3	-137
27 GHz to 35 GHz	25	25	6	± 0.3	± 0.3	-137
35 GHz to 40 GHz	25	25	6	± 0.3	± 0.3	-134
40 GHz to 44 GHz	20	20	9	± 0.5	± 0.5	-132

Crosstalk (Option 4K5/4K6)

Description	S13, S14, S23, S24	S31, S32, S41, S42
10 MHz to 50 MHz ³	-114	-151
50 MHz to 100 MHz	-114	-154
100 MHz to 1 GHz	-134	-154
1 GHz to 2 GHz	-145	-154
2 GHz to 3 GHz	-144	-154
3 GHz to 4.5 GHz	-144	-153
4.5 GHz to 5 GHz	-143	-152
5 GHz to 6.5 GHz	-142	-154
6.5 GHz to 9 GHz	-142	-151
9 GHz to 10 GHz	-140	-148
10 GHz to 14 GHz	-138	-148
14 GHz to 15 GHz	-138	-146
15 GHz to 16 GHz	-136	-145
16 GHz to 19 GHz	-133	-145
19 GHz to 20 GHz	-133	-141

Crosstalk (Option 4N5/4N6/4N7)

Description	S13, S14, S23, S24	S31, S32, S41, S42
10 MHz to 100 MHz ³	-114	-150
100 MHz to 200 MHz	-134	-150
200 MHz to 1 GHz	-134	-154
1 GHz to 2 GHz	-145	-154
2 GHz to 3 GHz	-144	-154
3 GHz to 5 GHz	-144	-152
5 GHz to 6.5 GHz	-143	-154
6.5 GHz to 9 GHz	-143	-151
9 GHz to 10 GHz	-143	-149
10 GHz to 15 GHz	-141	-149
15 GHz to 17 GHz	-139	-148
17 GHz to 19 GHz	-137	-146
19 GHz to 20 GHz	-137	-142
20 GHz to 22 GHz	-137	-145
22 GHz to 24 GHz	-137	-144
24 GHz to 25 GHz	-134	-142
25 GHz to 27 GHz	-132	-140
27 GHz to 30 GHz	-132	-141
30 GHz to 32 GHz	-130	-138
32 GHz to 33 GHz	-130	-136
33 GHz to 35 GHz	-130	-134
35 GHz to 36 GHz	-127	-132
36 GHz to 38 GHz	-127	-130
38 GHz to 40 GHz	-124	-129
40 GHz to 41 GHz	-119	-123
41 GHz to 44 GHz	-119	-113

1. Cable loss not included in transmission tracking.

2. Either port can be used as the source port. Any other port can be used as the receiver port.

3. It may typically be degraded at 25 MHz.

Table 12. Noise Mode Uncorrected System Performance with Port 1 and 2 (dB) – Specification

Option 2K5/2K6/4K5/4K6

Description	Source match	Load match
50 MHz to 500 MHz	8	8
500 MHz to 1 GHz	8	11
1 GHz to 4 GHz	13	11
4 GHz to 5 GHz	7	11
5 GHz to 10 GHz	7	10
10 GHz to 16 GHz	4	6
16 GHz to 20 GHz	4	5

Option 2N5/2N6/2N7/4N5/4N6/4N7

Description	Source match	Load match
50 MHz to 500 MHz	8	8
500 MHz to 1 GHz	8	10
1 GHz to 4 GHz	13	12
4 GHz to 5 GHz	7	12
5 GHz to 8.5 GHz	7	9
8.5 GHz to 10 GHz	7	8
10 GHz to 20 GHz	4	5
20 GHz to 25 GHz	4	5
25 GHz to 33 GHz	4	3
33 GHz to 37 GHz	4	2
37 GHz to 44 GHz	2	2

Table 13. Noise Mode Uncorrected System Performance with Port 1 and 2 (dB)¹ – Typical

Option 2K5/2K6/4K5/4K6

Description	Source match	Load match	Reflection tracking	Transmission tracking
50 MHz to 100 MHz	11	11	± 5	± 5
100 MHz to 500 MHz	11	11	± 5	± 5
500 MHz to 1 GHz	11	14	± 2	± 2
1 GHz to 2 GHz	18	14	± 1	± 1
2 GHz to 4 GHz	18	14	± 1	± 1
4 GHz to 5 GHz	10	14	± 1	± 1
5 GHz to 10 GHz	10	13	± 2	± 2
10 GHz to 15 GHz	7	10	+2 / -4	+2 / -4
15 GHz to 16 GHz	7	10	+2 / -3	+2 / -3
16 GHz to 20 GHz	7	9	+2 / -3	+2 / -3

Option 2N5/2N6/2N7/4N5/4N6/4N7

Description	Source match	Load match	Reflection tracking	Transmission tracking
50 MHz to 100 MHz	11	11	± 5	± 5
100 MHz to 500 MHz	11	11	± 5	± 5
500 MHz to 1 GHz	11	13	± 2	± 2
1 GHz to 2 GHz	18	15	± 1	± 1
2 GHz to 4 GHz	18	15	± 1	± 1
4 GHz to 5 GHz	10	15	± 1	± 1
5 GHz to 8.5 GHz	10	11	± 2	± 2
8.5 GHz to 10 GHz	10	10	± 2	± 2
10 GHz to 15 GHz	7	9	+2 / -4	+2 / -4
15 GHz to 20 GHz	7	9	+2 / -3	+2 / -3
20 GHz to 25 GHz	7	9	+2 / -3	+2 / -3
25 GHz to 30 GHz	7	6	+3 / -4	+3 / -4
30 GHz to 33 GHz	7	6	+3 / -4	+3 / -4
33 GHz to 35 GHz	7	5	+3 / -4	+3 / -4
35 GHz to 37 GHz	7	5	+4 / -8	+4 / -8
37 GHz to 40 GHz	4	5	+4 / -8	+4 / -8
40 GHz to 42 GHz	4	5	+4 / -10	+4 / -10
42 GHz to 44 GHz	4	5	+4 / -10	+4 / -10

1. Cable loss not included in transmission tracking.

Test Port Output ¹

Table 14. Frequency Resolution, Accuracy, Stability

Description	Specification	Typical
Frequency range	100 kHz to 20 GHz (Option 2K5/2K6/4K5/4K6) 100 kHz to 44 GHz (Option 2N5/2N6/2N7/4N5/4N6/4N7)	
Frequency resolution	1 Hz	--
Frequency accuracy	± 7 ppm ± 0.45 ppm (Option 1E5)	--
Frequency stability	--	± 7 ppm ² ± 0.05 ppm (Option 1E5) ² ± 3 ppm/year maximum ³ ± 0.1 ppm/year maximum (Option 1E5) ³

1. The specifications do not apply to parallel measurements of multiple devices under test (DUT).
2. 0 to 40 °C. Assumes no variation in time.
3. Assumes no variation in temperature.

Table 15. Maximum Output Port Power (dBm)

Port 1 and 2 (All Options)

Description	Specification	Typical
100 kHz to 1 MHz	9	11
1 MHz to 5 GHz	16	17
5 GHz to 6.5 GHz	17	19
6.5 GHz to 9 GHz	16	17
9 GHz to 15 GHz	15	16
15 GHz to 19 GHz	13	15
19 GHz to 20 GHz	10 ¹	11
20 GHz to 22 GHz	13	14
22 GHz to 24 GHz	12	13
24 GHz to 27 GHz	10	11
27 GHz to 30 GHz	8	12
30 GHz to 32 GHz	8	11
32 GHz to 33 GHz	4	9
33 GHz to 35 GHz	4	7
35 GHz to 36 GHz	3	5
36 GHz to 37.5 GHz	1	3
37.5 GHz to 39 GHz	1	3
39 GHz to 40 GHz	0	2
40 GHz to 41 GHz	-5	-4
41 GHz to 42 GHz	-16	-14
42 GHz to 44 GHz	-19	-14

1. Applies to the specification at 20 GHz.

Port 3 and 4 (Option 4K5/4K6)

Description	Specification	Typical
100 kHz to 10 MHz	5	7
10 MHz to 4.5 GHz	10	13
4.5 GHz to 6.5 GHz	10	12
6.5 GHz to 9 GHz	9	12
9 GHz to 16 GHz	7	10
16 GHz to 20 GHz	4	7

Port 3 and 4 (Option 4N5/4N6/4N7)

Description	Specification	Typical
100 kHz to 300 kHz	-2	1
300 kHz to 1 MHz	7	10
1 MHz to 17 GHz	10	13
17 GHz to 20 GHz	7	11
20 GHz to 30 GHz	5	8
30 GHz to 44 GHz	2	5

Table 16. Power Sweep Range (dBm)

Port 1 and 2 (All Options)

Description	Specification	Typical
100 kHz to 1 MHz	--	-80 to 11
1 MHz to 5 GHz	--	-80 to 17
5 GHz to 6.5 GHz	--	-80 to 19
6.5 GHz to 9 GHz	--	-80 to 17
9 GHz to 15 GHz	--	-80 to 16
15 GHz to 19 GHz	--	-80 to 15
19 GHz to 20 GHz	--	-80 to 12
20 GHz to 22 GHz	--	-80 to 14
22 GHz to 24 GHz	--	-80 to 13
24 GHz to 27 GHz	--	-80 to 11
27 GHz to 30 GHz	--	-80 to 12
30 GHz to 32 GHz	--	-80 to 11
32 GHz to 33 GHz	--	-80 to 9
33 GHz to 35 GHz	--	-80 to 7
35 GHz to 36 GHz	--	-80 to 5
36 GHz to 37.5 GHz	--	-80 to 3
37.5 GHz to 39 GHz	--	-80 to 3
39 GHz to 40 GHz	--	-80 to 2
40 GHz to 41 GHz	--	-80 to -4

Description	Specification	Typical
41 GHz to 44 GHz	--	-80 to -14

Port 3 and 4 (Option 4K5/4K6)

Description	Specification	Typical
100 kHz to 10 MHz	--	-60 to 7
10 MHz to 4.5 GHz	--	-60 to 13
4.5 GHz to 9 GHz	--	-60 to 12
9 GHz to 16 GHz	--	-60 to 10
16 GHz to 20 GHz	--	-60 to 7

Port 3 and 4 (Option 4N5/4N6/4N7)

Description	Specification	Typical
100 kHz to 300 kHz	--	-60 to 1
300 kHz to 1 MHz	--	-60 to 10
1 MHz to 17 GHz	--	-60 to 13
17 GHz to 20 GHz	--	-60 to 11
20 GHz to 24 GHz	--	-50 to 11
24 GHz to 38 GHz	--	-50 to 8
38 GHz to 44 GHz	--	-50 to 5

Table 17. Power Level Accuracy (dB) ¹

Port 1 and 2 (All Options) ^{2, 3}

Description	Specification	Typical
100 kHz to 1 MHz	± 2.0	± 0.3
1 MHz to 50 MHz	± 2.0	± 0.4
50 MHz to 15 GHz	± 1.5	± 0.4
15 GHz to 20 GHz	± 2.0	± 0.6
20 GHz to 25 GHz	± 2.0	± 0.5
25 GHz to 30 GHz	± 2.5	± 0.6
30 GHz to 37.5 GHz	± 3.5	± 1.2
37.5 GHz to 40 GHz	± 3.5	± 0.8
40 GHz to 44 GHz	± 5.0	± 1.8

Port 3 and 4 (Option 4K5/4K6)

Description	Specification	Typical
100 kHz to 15 GHz	± 1.5	± 0.2
15 GHz to 20 GHz	± 2.0	± 0.3

Port 3 and 4 (Option 4N5/4N6/4N7)

Description	Specification	Typical
100 kHz to 10 MHz	± 3.0	± 0.5
10 MHz to 15 GHz	± 1.5	± 0.2
15 GHz to 30 GHz	± 2.0	± 0.2
30 GHz to 40 GHz	± 2.5	± 0.3
40 GHz to 44 GHz	± 2.5	± 0.5

1. At power of 0 dBm (Opt.2K5/2K6/4K5/4K6) or -20 dBm (for port 1 and 2), -15 dBm (for port 3 and 4) (Opt.2N5/2N6/2N7/4N5/4N6/4N7), stepped sweep mode.
2. Instrument has been stored for a minimum of 48 hours in a stable environment before measurement. Instrument has been turned on for 24 hours with VNA application running.
3. Because the semi-rigid cable (connected between Upconverter RF1 Out and Src1 In ports) and the other semi-rigid cable (connected between Upconverter RF2 Out and Src2 In ports) have the same length, they can be exchanged and used for connection. However, exchanging cables is not recommended because the performance of power level accuracy may be degraded.

Table 18. Power Level Linearity (dB)

Port 1 and 2 (All Options)¹

Description	Specification ²	Typical ^{3,4}
100 kHz to 1 MHz	± 2.0	± 0.2
1 MHz to 10 GHz	± 0.75	± 0.2
10 GHz to 20 GHz	± 1.0	± 0.2
20 GHz to 30 GHz	± 1.5	± 0.4
30 GHz to 35 GHz	± 2.0	± 0.4
35 GHz to 44 GHz	± 2.5	± 0.5

1. Level linearity given is relative to 0 dBm (Opt.2K5/2K6/4K5/4K6) or -20 dBm (Opt.2N5/2N6/2N7/4N5/4N6/4N7).
2. Stepped sweep mode. -25 dBm ≤ P ≤ maximum specified power.
3. Swept sweep mode. -80 dBm ≤ P ≤ maximum specified power.
4. Stepped sweep mode. -80 dBm ≤ P < -20 dBm.

Port 3 and 4 (Option 4K5/4K6)⁵

Description	Specification ⁶	Typical ^{7,8}
100 kHz to 10 GHz	± 0.75	± 1.0
10 GHz to 20 GHz	± 1.0	± 1.0

5. Level linearity given is relative to 0 dBm.
6. Stepped sweep mode. -20 dBm ≤ P ≤ maximum specified power.
7. Swept sweep mode. -60 dBm ≤ P ≤ maximum specified power.
8. Stepped sweep mode. -60 dBm ≤ P < -20 dBm.

Port 3 and 4 (Option 4N5/4N6/4N7)⁹

Description	Specification ¹⁰	Typical
100 kHz to 10 GHz	± 0.75	± 1.0 ^{11, 12}
10 GHz to 20 GHz	± 1.0	± 1.0 ^{11, 12}
20 GHz to 44 GHz	± 2.0	± 1.0 ^{13, 14}

9. Level linearity given is relative to -15 dBm.

10. Stepped sweep mode. -20 dBm ≤ P ≤ maximum specified power.

11. Swept sweep mode. -60 dBm ≤ P ≤ maximum specified power.

12. Stepped sweep mode. -60 dBm ≤ P < -20 dBm.

13. Swept sweep mode. -65 dBm ≤ P ≤ maximum specified power.

14. Stepped sweep mode. -50 dBm ≤ P < -20 dBm.

Table 19. 2nd Harmonics (dBc) – Typical

Port 1 and 2 (All Options)

Description ¹	At -20 dBm	At max specified power
100 kHz to 500 MHz	-30	-24
500 MHz to 1 GHz	-50	-24
1 GHz to 10 GHz	-50	-20
10 GHz to 15 GHz	-50	-18
15 GHz to 19 GHz	-45	-16
19 GHz to 22 GHz	-35	-12

Port 3 and 4 (Option 4K5/4K6/4N5/4N6/4N7)

Description ¹	At 0 dBm	At max specified power
5 MHz to 10 GHz	-25	--
10 GHz to 12.5 GHz	-17	--
12.5 GHz to 20 GHz	-20	--
20 GHz to 22 GHz	-15	--

1. Listed frequency is fundamental frequency.

Table 20. 3rd Harmonics (dBc) – Typical

Port 1 and 2 (All Options)

Description ¹	At -20 dBm	At max specified power
100 kHz to 500 MHz	-30	-26
500 MHz to 1 GHz	-60	-26
1 GHz to 10 GHz	-60	-30
10 GHz to 14.67 GHz	-50	-25

Port 3 and 4 (Option 4K5/4K6/4N5/4N6/4N7)

Description ¹	At 0 dBm	At max specified power
3.33 MHz to 6.67 GHz	-25	--
6.67 GHz to 8.33 GHz	-17	--
8.33 GHz to 13.33 GHz	-20	--
13.33 GHz to 16.67 GHz	-15	--

1. Listed frequency is fundamental frequency.

Table 21. Sub-harmonics at Nominal Power (dBc)¹

Port 1 and 2 (All Options)²

Description	Specification	Typical
100 kHz to 5 GHz	--	-60
5 GHz to 20 GHz	--	-43
20 GHz to 42 GHz	--	-55
42 GHz to 44 GHz	--	-25

Port 3 and 4 (Option 4K5/4K6)³

Description	Specification	Typical
10 MHz to 20 GHz	--	-35

Port 3 and 4 (Option 4N5/4N6/4N7)²

Description	Specification	Typical
10 MHz to 10 GHz	--	-50
10 GHz to 20 GHz	--	-35
20 GHz to 40 GHz	--	-30
40 GHz to 44 GHz	--	-20

1. Listed frequency is fundamental frequency.
2. Tested at power of -20 dBm.
3. Tested at power of 0 dBm.

Table 22. Non-harmonic Spurs at Nominal Power (dBc) ¹Port 1 and 2 (All Options) ²

Description	Specification	Typical
100 kHz to 5 GHz	--	-60
5 GHz to 20 GHz	--	-43
20 GHz to 42 GHz	--	-55
42 GHz to 44 GHz	--	-25

Port 3 and 4 (Option 4K5/4K6) ³

Description	Specification	Typical
10 MHz to 10 GHz	--	-50
10 GHz to 20 GHz	--	-45

Port 3 and 4 (Option 4N5/4N6/4N7) ²

Description ¹	Specification	Typical
10 MHz to 10 GHz	--	-50
10 GHz to 20 GHz	--	-45
20 GHz to 44 GHz	--	-35

1. Listed frequency is fundamental frequency. Includes spurious related to LO signal and frac-N.
2. Tested at power of -20 dBm.
3. Tested at power of 0 dBm.

Table 23. Nominal Power (Preset Power Level)

Description	Specification
Option 2K5/2K6/4K5/4K6 (20 GHz)	0 dBm
Option 2N5/2N6/2N7/4N5/4N6/4N7 (44 GHz)	-20 dBm

Table 24. Power Resolution, Maximum/minimum Settable Power

Description	Specification	Typical
Settable resolution	--	0.01 dB
Maximum settable power	--	+30 dBm
Minimum settable power	--	-100 dBm

Test Port Input

Table 25. Noise Floor (dBm) ¹

Test port

Port 1 and 2 (All Options)

Description	Specification	Typical
100 kHz to 300 kHz	--	-59
300 kHz to 1 MHz	--	-70
1 MHz to 10 MHz	--	-80
10 MHz to 100 MHz ²	-96	-101
100 MHz to 1 GHz	-114	-121
1 GHz to 2 GHz	-130	-132
2 GHz to 5 GHz	-127	-131
5 GHz to 10 GHz	-126	-130
10 GHz to 15 GHz	-125	-128
15 GHz to 25 GHz	-123	-126
25 GHz to 30 GHz	-121	-124
30 GHz to 35 GHz	-119	-122
35 GHz to 40 GHz	-116	-119
40 GHz to 44 GHz	-109	-114

Port 3 and 4 (Option 4K5/4K6)

Description	Specification	Typical
100 kHz to 300 kHz	--	-119
300 kHz to 1 MHz	--	-127
1 MHz to 10 MHz	--	-132
10 MHz to 50 MHz ²	-127	-134
50 MHz 3 GHz	-130	-137
3 GHz to 4.5 GHz	-130	-136
4.5 GHz to 6.5 GHz	-130	-135
6.5 GHz to 9 GHz	-127	-134
9 GHz to 14 GHz	-126	-132
14 GHz to 16 GHz	-123	-130
16 GHz to 20 GHz	-122	-130

Port 3 and 4 (Option 4N5/4N6/4N7)

Description	Specification	Typical
100 kHz to 300 kHz	--	-105
300 kHz to 500 kHz	--	-110
500 kHz to 1 MHz	--	-120
1 MHz to 10 MHz	--	-124
10 MHz to 50 MHz ²	-127	-133
50 MHz to 200 MHz	-130	-133
200 MHz to 3 GHz	-130	-137
3 GHz to 6.5 GHz	-130	-135
6.5 GHz to 9 GHz	-128	-134
9 GHz to 17 GHz	-127	-133
17 GHz to 25 GHz	-125	-131
25 GHz to 30 GHz	-122	-129
30 GHz to 44 GHz	-120	-127

Test port with low noise path (port 1 and 2)

Description	Specification	Typical
100 kHz to 300 kHz	--	-125
300 kHz to 1 MHz	--	-126
1 MHz to 10 MHz	--	-132
10 MHz to 100 MHz ²	--	-147
100 MHz to 2 GHz	--	-152
2 GHz to 5 GHz	--	-151
5 GHz to 10 GHz	--	-151
10 GHz to 15 GHz	--	-150
15 GHz to 20 GHz	--	-148
20 GHz to 25 GHz	--	-146
25 GHz to 30 GHz	--	-148
30 GHz to 35 GHz	--	-146
35 GHz to 40 GHz	--	-144
40 GHz to 44 GHz	--	-140

Direct receiver access port (Rcvr A In, Rcvr B In, Rcvr R1 In, Rcvr R2 In) with port 1 and 2

Port 1 and 2 (All Options)

Description	Specification	Typical
100 kHz to 300 kHz	--	-144
300 kHz to 1 MHz	--	-148
1 MHz to 10 MHz	--	-149
10 MHz to 100 MHz ²	--	-147
100 MHz to 1 GHz	--	-147
1 GHz to 2 GHz	--	-145
2 GHz to 5 GHz	--	-144
5 GHz to 10 GHz	--	-142
10 GHz to 15 GHz	--	-140
15 GHz to 20 GHz	--	-139
20 GHz to 25 GHz	--	-137
25 GHz to 30 GHz	--	-134
30 GHz to 35 GHz	--	-133
35 GHz to 40 GHz	--	-127
40 GHz to 44 GHz	--	-123

1. Noise floor in a 10 Hz IF Bandwidth. Measured with 30 kHz IF bandwidth. Test port terminated.

2. It may typically be degraded at 25 MHz.

Table 26. Receiver Compression at Test Port

Port 1 and 2 (All Options)^{1,2}

Description	Input power at test port (dBm)	Specification		Typical	
		Magnitude (dB)	Phase (°)	Magnitude (dB)	Phase (°)
500 MHz to 15 GHz	+13	0.15	1.5	--	--
15 GHz to 20 GHz	+10	0.15	1.5	--	--
20 GHz to 26.5 GHz	+13	0.15	1.5	--	--
26.5 GHz to 38 GHz	+8	0.15	1.5	--	--
38 GHz to 40 GHz	+7	0.15	1.5	--	--
40 GHz to 44 GHz	+5	0.15	1.5	--	--

Port 3 and 4 (Option 4K5/4K6)³

Description	Input power at test port (dBm)	Specification		Typical	
		Magnitude (dB)	Phase (°)	Magnitude (dB)	Phase (°)
10 MHz to 6.5 GHz	+10	0.2	5	0.05	1.0
6.5 GHz to 9 GHz	+9	0.2	5	0.05	1.0
9 GHz to 16 GHz	+7	0.2	5	0.05	1.0
16 GHz to 20 GHz	+4	0.2	5	0.05	1.0

Port 3 and 4 (Option 4N5/4N6/4N7)³

Description	Input power at test port (dBm)	Specification		Typical	
		Magnitude (dB)	Phase (°)	Magnitude (dB)	Phase (°)
10 MHz to 17 GHz	+10	0.2	5	0.05	1.0
17 GHz to 20 GHz	+7	0.2	5	0.05	1.0
20 GHz to 30 GHz	+5	0.2	5	0.05	1.0
30 GHz to 44 GHz	+2	0.2	5	0.05	1.0

1. Tested with receiver gain AUTO. (18 dB receiver attenuator is selected for measurements)
2. Receiver compression at test port below 500 MHz is negligible due to the coupler roll off.
3. Tested with receiver gain AUTO. (High receiver attenuator is selected for measurements)

Table 27. Trace Noise Magnitude (dB rms)¹

Option 2K5/2K6/4K5/4K6 – Specification

Description	Port ^{2,3,4} 1, 2	Port ^{2,3,5,6} 3, 4	S13, S14, S23, S24 ^{7,8}	S31, S32, S41, S42 ^{7,9}
10 MHz to 100 MHz	0.03	0.0015	0.0597	0.0597
100 MHz to 500 MHz	0.0045	0.0015	0.0088	0.0088
500 MHz to 2 GHz	0.0017	0.0015	0.0032	0.0032
2 GHz to 5 GHz	0.0017	0.0015	0.0032	0.0032
5 GHz to 6 GHz	0.0017	0.0015	0.0036	0.0036
6 GHz to 9 GHz	0.0017	0.002	0.0036	0.0036
9 GHz to 10 GHz	0.0017	0.002	0.004	0.004
10 GHz to 15 GHz	0.002	0.003	0.0048	0.0048
15 GHz to 16 GHz	0.0025	0.003	0.0048	0.0048
16 GHz to 17 GHz	0.0025	0.003	0.0067	0.0067
17 GHz to 19 GHz	0.0025	0.003	0.0065	0.0065
19 GHz to 20 GHz	0.003	0.003	0.0057	0.0057

Option 2K5/2K6/4K5/4K6 – Typical

Description	Port ^{2,3,4} 1, 2	Port ^{2,3,5,6} 3, 4	S13, S14, S23, S24 ^{7,8}	S31, S32, S41, S42 ^{7,9}
10 MHz to 100 MHz	0.0125	0.0005	0.025	0.025
100 MHz to 500 MHz	0.0017	0.0005	0.0034	0.0034
500 MHz to 2 GHz	0.0005	0.0005	0.001	0.001
2 GHz to 5 GHz	0.0006	0.0005	0.0012	0.0012
5 GHz to 6 GHz	0.0006	0.0005	0.0014	0.0014
6 GHz to 9 GHz	0.0006	0.0006	0.0014	0.0014
9 GHz to 10 GHz	0.0006	0.0006	0.0016	0.0016
10 GHz to 15 GHz	0.0008	0.001	0.0021	0.0021
15 GHz to 16 GHz	0.001	0.001	0.002	0.002
16 GHz to 17 GHz	0.001	0.001	0.0029	0.0029
17 GHz to 19 GHz	0.0015	0.001	0.0043	0.0043
19 GHz to 20 GHz	0.0015	0.001	0.003	0.003

Option 2N5/2N6/2N7/4N5/4N6/4N7 – Specification

Description	Port ^{2,3,4} 1, 2	Port ^{2,3,5,6} 3, 4	S13, S14, S23, S24 ^{7,8}	S31, S32, S41, S42 ^{7,9}
10 MHz to 100 MHz	0.03	0.0015	0.0597	0.0597
100 MHz to 500 MHz	0.0045	0.0015	0.0088	0.0088
500 MHz to 5 GHz	0.0017	0.0015	0.0032	0.0032
5 GHz to 6.5 GHz	0.0017	0.0015	0.0036	0.0036
6.5 GHz to 9 GHz	0.0017	0.0015	0.0032	0.0032
9 GHz to 10 GHz	0.0017	0.0015	0.0029	0.0029
10 GHz to 15 GHz	0.002	0.002	0.0034	0.0034
15 GHz to 17 GHz	0.0025	0.002	0.0035	0.0035
17 GHz to 19 GHz	0.0025	0.003	0.0047	0.0047
19 GHz to 20 GHz	0.003	0.003	0.0042	0.0042
20 GHz to 22 GHz	0.0038	0.003	0.0091	0.0091
22 GHz to 24 GHz	0.0038	0.003	0.0082	0.0082
24 GHz to 25 GHz	0.0045	0.003	0.0078	0.0078
25 GHz to 27 GHz	0.0056	0.003	0.0098	0.0098
27 GHz to 30 GHz	0.0056	0.003	0.0078	0.0078
30 GHz to 32 GHz	0.0056	0.006	0.0102	0.0102
32 GHz to 35 GHz	0.008	0.006	0.0099	0.0099
35 GHz to 36 GHz	0.0174	0.006	0.0194	0.0194
36 GHz to 39 GHz	0.0174	0.006	0.0157	0.0174
39 GHz to 40 GHz	0.0174	0.006	0.0141	0.0174
40 GHz to 41 GHz	0.0174	0.006	0.0084	0.0174
41 GHz to 42 GHz	0.0502	0.006	0.0072	0.0502
42 GHz to 44 GHz	0.0951	0.006	0.0094	0.0951

Option 2N5/2N6/2N7/4N5/4N6/4N7 – Typical

Description	Port ^{2,3,4} 1, 2	Port ^{2,3,5,6} 3, 4	S13, S14, S23, S24 ^{7,8}	S31, S32, S41, S42 ^{7,9}
10 MHz to 100 MHz	0.0125	0.0005	0.025	0.0025
100 MHz to 500 MHz	0.0017	0.0005	0.0034	0.0034
500 MHz to 2 GHz	0.0005	0.0005	0.001	0.001
2 GHz to 4.5 GHz	0.0006	0.0005	0.0012	0.0012
4.5 GHz to 5 GHz	0.0006	0.0007	0.0012	0.0012
5 GHz to 6.5 GHz	0.0006	0.0007	0.0014	0.0014
6.5 GHz to 9 GHz	0.0006	0.0007	0.0012	0.0012
9 GHz to 10 GHz	0.0006	0.0007	0.0011	0.0011
10 GHz to 15 GHz	0.0008	0.001	0.0015	0.0015
15 GHz to 17 GHz	0.001	0.001	0.0015	0.0015
17 GHz to 19 GHz	0.0015	0.0013	0.003	0.003
19 GHz to 20 GHz	0.0015	0.0013	0.0022	0.0022
20 GHz to 22 GHz	0.0015	0.0013	0.0038	0.0038
22 GHz to 24 GHz	0.0015	0.0013	0.0034	0.0034
24 GHz to 25 GHz	0.002	0.0013	0.0036	0.0036
25 GHz to 27 GHz	0.0025	0.0013	0.0045	0.0045
27 GHz to 30 GHz	0.0025	0.0013	0.0036	0.0036
30 GHz to 32 GHz	0.0035	0.0022	0.007	0.007
32 GHz to 35 GHz	0.0055	0.0022	0.007	0.007
35 GHz to 36 GHz	0.0055	0.0022	0.0062	0.0062
36 GHz to 37 GHz	0.0055	0.0022	0.0049	0.0055
37 GHz to 39 GHz	0.008	0.0022	0.0072	0.008
39 GHz to 40 GHz	0.008	0.0022	0.0064	0.008
40 GHz to 41 GHz	0.008	0.0022	0.0036	0.008
41 GHz to 42 GHz	0.04	0.0022	0.0051	0.04
42 GHz to 44 GHz	0.075	0.0022	0.0067	0.075

1. Transmission and reflection trace noise in a 10 kHz IF bandwidth.
2. At maximum specified power.
3. Either port can be used as the source port. Any other port can be used as the receiver port.
4. It may typically be degraded at particular frequencies such as 108 MHz, 120 MHz, 132 MHz, 143 MHz, 149 MHz or 156 MHz.
5. 4-port options only.
6. It may typically be degraded at particular frequencies such as 25 MHz, 54 MHz, 58.5 MHz, 108 MHz, 120 MHz, 132 MHz, 143 MHz or 156 MHz.
7. It may typically be degraded at particular frequencies such as 25 MHz, 54 MHz, 58.5 MHz, 108 MHz, 120 MHz, 132 MHz, 143 MHz, 149 MHz or 156 MHz.
8. At maximum specified power at port 3 and 4.
9. At maximum specified power at port 1 and 2 or maximum specified power at port 3 and 4, whichever is lower.

Table 28. Trace Noise Phase (degree rms) ¹

Option 2K5/2K6/4K5/4K6 – Specification

Description	Port ^{2,3,4} 1, 2	Port ^{2,3,5,6} 3, 4	S13, S14, S23, S24 ^{7,8}	S31, S32, S41, S42 ^{7,9}
10 MHz to 100 MHz	0.2	0.01	0.387	0.387
100 MHz to 500 MHz	0.03	0.01	0.057	0.057
500 MHz to 2 GHz	0.011	0.01	0.02	0.02
2 GHz to 5 GHz	0.011	0.01	0.02	0.02
5 GHz to 6 GHz	0.011	0.01	0.023	0.023
6 GHz to 9 GHz	0.011	0.02	0.023	0.023
9 GHz to 10 GHz	0.011	0.02	0.025	0.025
10 GHz to 15 GHz	0.013	0.03	0.03	0.03
15 GHz to 16 GHz	0.016	0.03	0.03	0.03
16 GHz to 19 GHz	0.016	0.03	0.042	0.042
19 GHz to 20 GHz	0.018	0.03	0.034	0.034

Option 2K5/2K6/4K5/4K6 – Typical

Description	Port ^{2,3,4} 1, 2	Port ^{2,3,5,6} 3, 4	S13, S14, S23, S24 ^{7,8}	S31, S32, S41, S42 ^{7,9}
10 MHz to 100 MHz	0.0707	0.003	0.142	0.142
100 MHz to 500 MHz	0.0112	0.003	0.023	0.023
500 MHz to 2 GHz	0.0028	0.003	0.006	0.006
2 GHz to 5 GHz	0.0045	0.003	0.009	0.009
5 GHz to 6 GHz	0.0045	0.003	0.011	0.011
6 GHz to 9 GHz	0.0045	0.006	0.011	0.011
9 GHz to 10 GHz	0.0045	0.006	0.012	0.012
10 GHz to 13.5 GHz	0.006	0.006	0.016	0.016
13.5 GHz to 15 GHz	0.006	0.01	0.016	0.016
15 GHz to 16 GHz	0.0081	0.01	0.017	0.017
16 GHz to 17 GHz	0.0081	0.01	0.023	0.023
17 GHz to 19 GHz	0.013	0.01	0.037	0.037
19 GHz to 20 GHz	0.013	0.01	0.026	0.026

Option 2N5/2N6/2N7/4N5/4N6/4N7 – Specification

Description	Port ^{2,3,4} 1, 2	Port ^{2,3,5,6} 3, 4	S13, S14, S23, S24 ^{7,8}	S31, S32, S41, S42 ^{7,9}
10 MHz to 100 MHz	0.2	0.02	0.387	0.387
100 MHz to 500 MHz	0.03	0.02	0.057	0.057
500 MHz to 5 GHz	0.011	0.02	0.02	0.02
5 GHz to 6.5 GHz	0.011	0.02	0.023	0.023
6.5 GHz to 9 GHz	0.011	0.02	0.02	0.02
9 GHz to 10 GHz	0.011	0.02	0.018	0.018

Description	Port ^{2,3,4} 1, 2	Port ^{2,3,5,6} 3, 4	S13, S14, S23, S24 ^{7,8}	S31, S32, S41, S42 ^{7,9}
10 GHz to 15 GHz	0.013	0.02	0.022	0.022
15 GHz to 17 GHz	0.016	0.02	0.022	0.022
17 GHz to 19 GHz	0.016	0.02	0.03	0.03
19 GHz to 20 GHz	0.018	0.02	0.025	0.025
20 GHz to 22 GHz	0.03	0.02	0.073	0.073
22 GHz to 24 GHz	0.03	0.02	0.065	0.065
24 GHz to 27 GHz	0.03	0.02	0.052	0.052
27 GHz to 30 GHz	0.03	0.02	0.042	0.042
30 GHz to 32 GHz	0.045	0.04	0.086	0.086
32 GHz to 35 GHz	0.07	0.04	0.088	0.088
35 GHz to 36 GHz	0.14	0.04	0.157	0.157
36 GHz to 39 GHz	0.14	0.04	0.126	0.14
39 GHz to 40 GHz	0.14	0.04	0.113	0.14
40 GHz to 41 GHz	0.14	0.04	0.065	0.14
41 GHz to 42 GHz	0.55	0.04	0.073	0.55
42 GHz to 44 GHz	0.8	0.04	0.075	0.8

Option 2N5/2N6/2N7/4N5/4N6/4N7 – Typical

Description	Port ^{2,3,4} 1, 2	Port ^{2,3,5,6} 3, 4	S13, S14, S23, S24 ^{7,8}	S31, S32, S41, S42 ^{7,9}
10 MHz to 100 MHz	0.0707	0.003	0.142	0.142
100 MHz to 500 MHz	0.0112	0.003	0.023	0.023
500 MHz to 2 GHz	0.0028	0.003	0.006	0.006
2 GHz to 5 GHz	0.0045	0.003	0.009	0.009
5 GHz to 6 GHz	0.0045	0.003	0.011	0.011
6 GHz to 6.5 GHz	0.0045	0.004	0.011	0.011
6.5 GHz to 9 GHz	0.0045	0.004	0.009	0.009
9 GHz to 10 GHz	0.0045	0.004	0.008	0.008
10 GHz to 15 GHz	0.006	0.006	0.011	0.011
15 GHz to 17 GHz	0.0081	0.006	0.012	0.012
17 GHz to 19 GHz	0.013	0.01	0.026	0.026
19 GHz to 20 GHz	0.013	0.01	0.019	0.019
20 GHz to 22 GHz	0.013	0.01	0.033	0.033
22 GHz to 24 GHz	0.013	0.01	0.03	0.03
24 GHz to 25 GHz	0.017	0.01	0.031	0.031
25 GHz to 27 GHz	0.02	0.01	0.036	0.036
27 GHz to 30 GHz	0.02	0.01	0.029	0.029
30 GHz to 32 GHz	0.025	0.018	0.05	0.05
32 GHz to 35 GHz	0.045	0.018	0.057	0.057
35 GHz to 36 GHz	0.045	0.018	0.051	0.051
36 GHz to 37 GHz	0.045	0.018	0.041	0.045
37 GHz to 39 GHz	0.05	0.018	0.045	0.05

Description	Port ^{2,3,4} 1, 2	Port ^{2,3,5,6} 3, 4	S13, S14, S23, S24 ^{7,8}	S31, S32, S41, S42 ^{7,9}
39 GHz to 40 GHz	0.05	0.018	0.04	0.05
40 GHz to 41 GHz	0.05	0.018	0.023	0.05
41 GHz to 42 GHz	0.3	0.018	0.038	0.3
42 GHz to 44 GHz	0.5	0.018	0.045	0.5

1. Transmission and reflection trace noise in a 10 kHz IF bandwidth.
2. At maximum specified power.
3. Either port can be used as the source port. Any other port can be used as the receiver port.
4. It may typically be degraded at particular frequencies such as 108 MHz, 120 MHz, 132 MHz, 143 MHz, 149 MHz or 156 MHz.
5. 4-port options only.
6. It may typically be degraded at particular frequencies such as 25 MHz, 54 MHz, 58.5 MHz, 108 MHz, 120 MHz, 132 MHz, 143 MHz or 156 MHz.
7. It may typically be degraded at particular frequencies such as 25 MHz, 54 MHz, 58.5 MHz, 108 MHz, 120 MHz, 132 MHz, 143 MHz, 149 MHz or 156 MHz.
8. At maximum specified power at port 3 and 4.
9. At maximum specified power at port 1 and 2 or maximum specified power at port 3 and 4, whichever is lower.

Table 29. Temperature Stability – Typical

Port 1 and 2 (All Options)^{1,2}

Description	Magnitude (dB/°C)	Phase (degree/°C)
10 MHz to 10 GHz	0.005	0.1
10 GHz to 20 GHz	0.01	0.2
20 GHz to 25 GHz	0.015	0.25
25 GHz to 30 GHz	0.015	0.3
30 GHz to 35 GHz	0.02	0.3
35 GHz to 40 GHz	0.025	0.5
40 GHz to 44 GHz	0.04	0.7

Port 3 and 4 (Option 4K5/4K6)¹

Description	Magnitude (dB/°C)	Phase (degree/°C)
100 kHz to 300 kHz	0.03	0.2
300 kHz to 4.5 GHz	0.005	0.1
4.5 GHz to 6 GHz	0.01	0.1
6 GHz to 6.5 GHz	0.01	0.2
6.5 GHz to 10 GHz	0.015	0.2
10 GHz to 14 GHz	0.015	0.3
14 GHz to 20 GHz	0.02	0.4

Port 3 and 4 (Option 4N5/4N6/4N7) ¹

Description	Magnitude (dB/°C)	Phase (degree/°C)
100 kHz to 1 MHz	0.03	1
1 MHz to 10 MHz	0.005	0.2
10 MHz to 4.5 GHz	0.005	0.1
4.5 GHz to 10 GHz	0.01	0.1
10 GHz to 20 GHz	0.01	0.2
20 GHz to 30 GHz	0.01	0.25
30 GHz to 40 GHz	0.01	0.3
40 GHz to 44 GHz	0.03	0.8

1. Either port can be used as the source port. Any other port can be used as the receiver port.
2. It also applies to S13, S14, S23, S24, S31, S32, S41 or S42 measurements.

Table 30. Damage Input Level at Test Ports

Description	
Damage Input Level	+27 dBm or ± 35 VDC (Warranted)

Noise Receiver Input (Port 1 and 2 with Option 0K1/0K2/0N1/0N2)

Table 31. Noise Receiver Bandwidth

Description	Allowable Bandwidth
50 MHz to 44 GHz	800 kHz, 1/2/4/8/12/24 MHz ¹

1. 8 to 24 MHz bandwidths are available only with calibration using noise source.

Table 32. Receiver Noise Figure (dB)

Description	Specification	Typical
50 MHz to 100 MHz	18	14
100 MHz to 200 MHz	12	9
200 MHz to 2 GHz	11	10
2 GHz to 5 GHz	12	10
5 GHz to 15 GHz	13	11
15 GHz to 20 GHz ¹	15	13
20 GHz to 25 GHz	17	15
25 GHz to 30 GHz	16	13
30 GHz to 35 GHz	17	15
35 GHz to 40 GHz	20	17
40 GHz to 44 GHz ^{2, 3}	26	21

1. For 20 GHz options, tested at up to 19.975 GHz
2. Above 40 GHz, an external bandpass filter may be required for NF measurements.
3. Tested at up to 43.975 GHz.

Table 33. Noise Figure Trace Noise (dB rms) at 4 MHz BW¹

Description	Specification	Typical
50 MHz to 44 GHz	0.11	0.07

1. All gain settings. Trace noise magnitude performance on noise figure trace or sometime called noise jitter, 201 points, 15 noise average, port 1 and 2 terminated.

Table 34. Noise Receiver Linearity (dB) at 4 MHz BW¹ – Specification

Low Gain Setting Reference to -35 dBm	Medium Gain Setting Reference to -55 dBm	High Gain Setting Reference to -80 dBm	
-10 to -5	-30 to -25	-60 to -55	± 0.09 (Low Gain and Medium Gain) ± 0.15 (High Gain)
-40 to -10	-60 to -30	-85 to -60	± 0.05
-85 to -40	-105 to -60	-130 to -85	± 0.07

1. The VNA receiver is linear by design when signal levels are below -65 dBm for low gain setting, -85 dBm for medium gain setting, and -110 dBm for high gain setting.

Table 35. Noise Receiver Input Range – Specification

Description	Max DUT NF + Gain (dB) ¹			Max Input Power (dBm) for <0.2 dB Compression		
	High Gain Setting	Medium Gain Setting	Low Gain Setting	High Gain Setting	Medium Gain Setting	Low Gain Setting ³
50 MHz to 500 MHz ²	30	-	-	-58	-	-
500 MHz to 2 GHz ²	35	73	101	-53	-15	13
2 GHz to 4.5 GHz ²	37	73	101	-51	-15	13
4.5 GHz to 10 GHz ²	42	73	101	-46	-15	13
10 GHz to 15 GHz	42	78	101	-46	-10	13
15 GHz to 20 GHz	42	78	98	-46	-10	10
20 GHz to 26.5 GHz	41	78	101	-47	-10	13
26.5 GHz to 32 GHz ²	41	78	96	-47	-10	8
32 GHz to 38 GHz	45	78	96	-43	-10	8
38 GHz to 40 GHz ²	45	78	95	-43	-10	7
40 GHz to 44 GHz	48	78	93	-40	-10	5

1. Limited by 0.2 dB receiver compression. Applies to devices with bandwidth <400 MHz. For devices with higher bandwidths, calculate the DUT output noise power as $-174 \text{ dBm} + 10 \cdot \log_{10}(B) + \text{Gain (dB)} + \text{NF (dB)}$, where B is the bandwidth of the DUT in Hz, and use the Max Input Power specification.
2. Applies to the specification at maximum frequency points (ex. 500 MHz, 2 GHz, 4.5 GHz, 10 GHz, 32 GHz, and 40 GHz).
3. The performance is tested at Receiver Compression at Test Port (Table 26).

Dynamic Accuracy

Accuracy of the test port input power relative to the reference input power level. Measured with 10 Hz IF bandwidth.

Dynamic accuracy¹ – specification

Port 1 and 2 (all options)

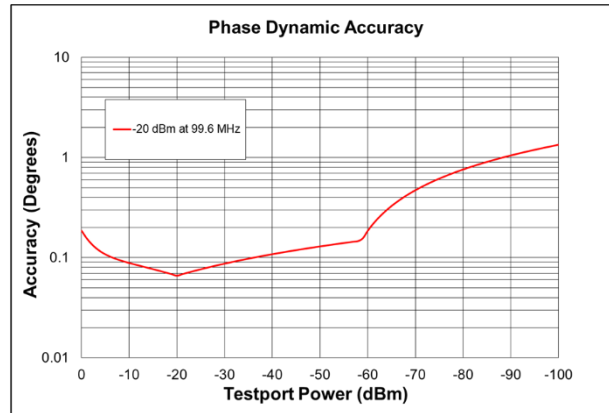
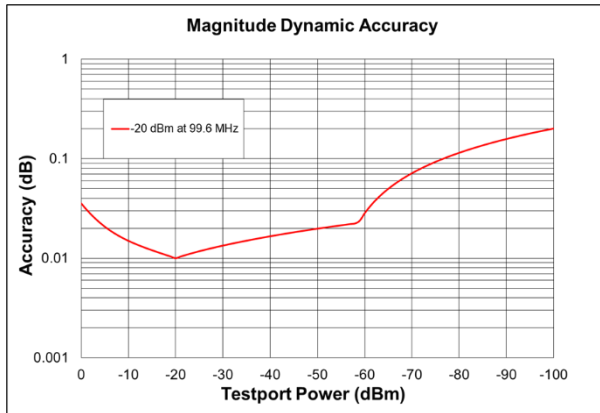

Port 3 and 4 (Option 4K5/4K6)

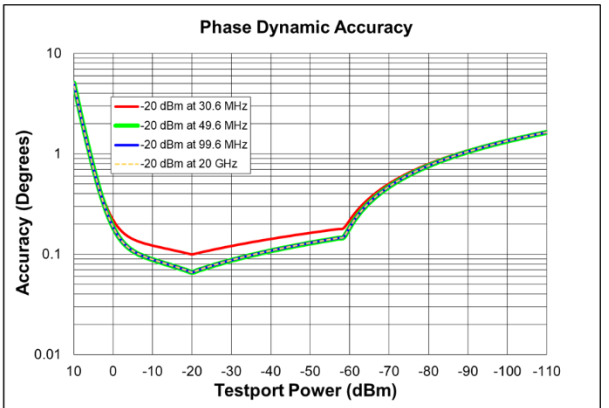
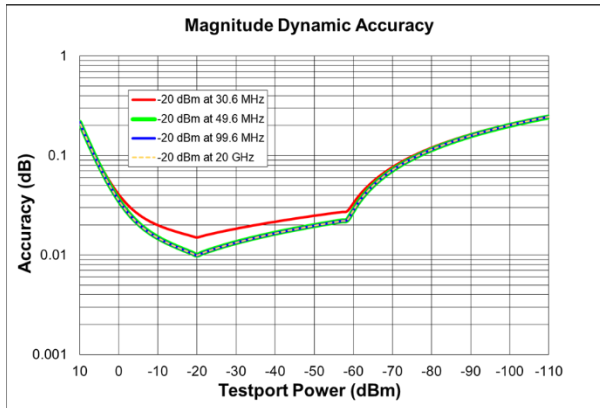

Port 3 and 4 (Option 4N5/4N6/4N7)

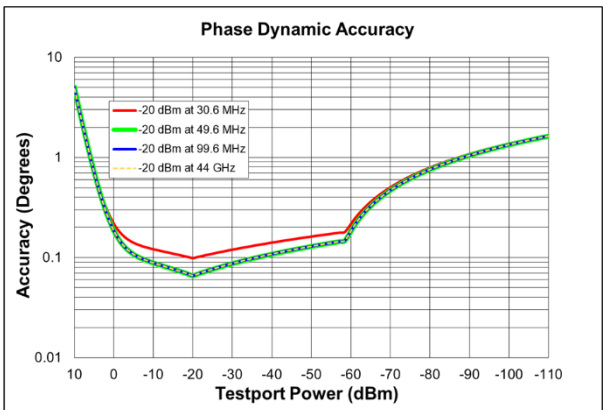
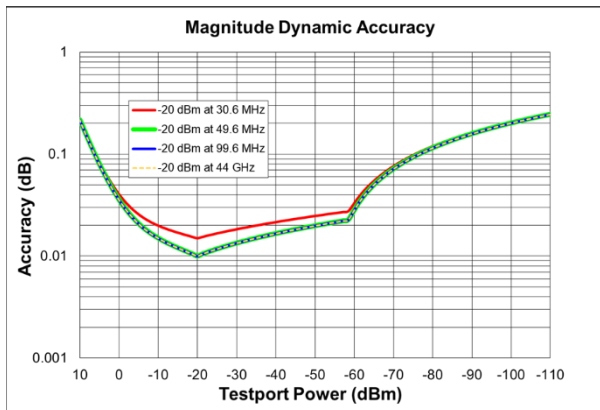

- Dynamic accuracy is verified with the following measurements:
 - Compression over frequency.
 - IF linearity at the test ports using a reference level of -20 dBm for an input power range of 0 to -60 dBm. Tested at a single frequency (99.6MHz for port 1 and 2) or three single frequencies (30.6 MHz, 49.6 MHz and 99.6 MHz for port 3 and 4) to cover the whole frequency range. The VNA receiver is linear by design when signal levels are below -60 dBm. For more details, refer to [VNA Receiver Dynamic Accuracy Specifications and Uncertainties](#).
 - Tested at the direct receiver access ports while the IF input level is adjusted to the equivalent input power level at the test ports of port 1 and 2.
- Download Uncertainty Calculator from http://www.keysight.com/find/na_calculator to generate the curves of dynamic accuracy at the test ports.

Spectrum Analysis (with S96090xB)

This section provides specifications for spectrum analysis of the E5081A ENA-X. S960904B (for 20 GHz options) or S960907B (for 44 GHz options) software is required to enable spectrum analysis functionality of the E5081A.

Table 36. Frequency Specifications

Description	Specification	Typical
Frequency Reference ¹		
Accuracy	--	± [(time since last adjustment x aging rate) + temperature stability + calibration accuracy], typical
Aging rate	--	± 3 ppm/year maximum, typical ± 0.1 ppm/year maximum, typical (Option 1E5)
Temperature stability	--	± 7 ppm (0 to 40 °C) ±0.45 ppm (0 to 40 °C) (Option 1E5)
Achievable initial calibration accuracy	± 7 ppm (25 ± 5 °C)	--
Frequency readout accuracy (Start, Stop, Center, Marker)	--	± [(readout frequency x frequency reference accuracy) + (< 1% x RBW)], nominal
Frequency Span		
Minimum/Maximum	Analyzer's full span ²	--
Resolution	1 Hz	--
Sweep (Trace) point range	11 to 100,003	--
Resolution Bandwidth (RBW)		
Range (-3 dB bandwidth)	10 Hz to 3 MHz in 10% steps	--
Bandwidth range accuracy	--	± 1%, all RBW, except below 100 MHz with 3 MHz RBW
Selectivity (-60 dB/-3 dB)	--	Gaussian: 4.5:1, Flat top: 2.47:1, Kaiser: 3.82:1, Blackman: 3.58:1
Video Bandwidth (VBW)		
Range	10 Hz to 3 MHz	--

- Frequency reference accuracy can be improved by using external frequency reference with better accuracy.
- When multitone is enabled, measurement frequency range is limited from 100 MHz to the maximum frequency minus 30 MHz.

Table 37. Time Specifications

Description	Specification	Supplemental information
Sweep Time and Triggering		
Sweep time range	Auto	--
Trigger types	Continuous, Single, Group, Manual, External	--
Trigger delay range	0 to 3 s	--
Trigger delay resolution	1 μ s	--
Measuring and Display Update Rate (milliseconds) ¹		
20 MHz Span, 3 kHz RBW, 3 kHz VBW	--	62.0
100 MHz Span, Auto RBW, Auto VBW	--	62.2
1 GHz Span, 3 kHz RBW, 3 kHz VBW	--	188.4
1 GHz Span, 300 kHz RBW, 300 kHz VBW	--	62.8
10 GHz Span, 3 kHz RBW, 3 kHz VBW	--	1374.3
10 GHz Span, 300 kHz RBW, 300 kHz VBW	--	313.0
10 MHz to 20 GHz, RBW/VBW = 1 MHz	--	311.5
10 MHz to 44 GHz, RBW/VBW = 1 MHz	--	562.0

1. Measured with a 2-port option with firmware revision A.17.05.06.

Table 38. Amplitude Accuracy and Range Specifications

Description	Specification
Amplitude Range	
Measurement range	DANL to maximum input level
Input attenuator range	0 to 30 dB, 2 dB step (Port 1 and 2) High attenuation or Low attenuation (Port 3 and 4)
Maximum safe input level	+27 dBm
Display Range	
Log scale	0.001 to 500 dB/div in 0.001 steps
Linear scale	10 divisions (default)
Scale units	dBm, mW
Trace detectors types	Average, Sample, Peak, Normal, Negative Peak, Peak sample, Peak average

Table 39. SA Detector Accuracy (dB) ¹ – Specifications

Description	Port ² 1, 2	Port 3, 4
100 kHz to 10 MHz	--	± 0.15
10 MHz to 20 GHz ³	± 0.1	± 0.1
20 GHz to 40 GHz	± 0.15	± 0.15
40 GHz to 44 GHz ⁴	± 0.18	± 0.15

1. With 18 dB attenuation on port 1 and 2, and with high attenuation on port 3 and 4. SA detector accuracy is residual error of IF response calibration. IF response is characterized with E5081A's standard measurement class after power and S-parameter calibration. Therefore, the SA total absolute amplitude accuracy includes power meter, S-parameter and SA detector accuracies. Add input attenuation switching uncertainty if receiver attenuator is changed after user calibration.
2. Tested at the test ports (without low noise path).
3. Tested up to 19.99 GHz (Option 2K5/2K6/4K5/4K6).
4. Tested up to 43.99 GHz (Option 2N5/2N6/2N7/4N5/4N6/4N7).

Table 40. Input Attenuation Switching Uncertainty (dB) – Supplemental Information

Description	Supplemental information
100 kHz to 50 MHz	± 0.5
50 MHz to 44 GHz	± 1.0

Table 41. Input VSWR ¹ – Specifications

Option 2K5/2K6/4K5/4K6

Description	Port 1, 2	Port ² 3, 4
10 MHz to 500 MHz	1.288	1.377
500 MHz to 2.5 GHz	1.499	1.377
2.5 GHz to 3 GHz	1.499	1.433
3 GHz to 5 GHz	1.499	1.785

Description	Port 1, 2	Port ² 3, 4
5 GHz to 7 GHz	1.785	1.785
7 GHz to 10 GHz	1.785	1.925
10 GHz to 14 GHz	1.925	1.925
14 GHz to 16 GHz	2.615	1.925
16 GHz to 17 GHz	2.615	2.323
17 GHz to 20 GHz	2.615	3.010

Option 2N5/2N6/2N7/4N5/4N6/4N7

Description	Port 1, 2	Port ² 3, 4
10 MHz to 500 MHz	1.377	1.377
500 MHz to 1 GHz	1.577	1.377
1 GHz to 4 GHz	1.577	1.499
4 GHz to 5 GHz	1.577	1.671
5 GHz to 9 GHz	1.925	1.671
9 GHz to 10 GHz	1.925	1.785
10 GHz to 20 GHz	2.615	2.100
20 GHz to 25 GHz	2.615	2.323
25 GHz to 27 GHz	4.419	2.615
27 GHz to 33 GHz	4.419	3.570
33 GHz to 40 GHz	8.724	3.570
40 GHz to 44 GHz	8.724	3.010

1. Calculated by load match of uncorrected error terms (Table 10). $VSWR = \frac{1+10^{(-1+load\ match/20)}}{1-10^{(-1+load\ match/20)}}$
2. 4-port options only.

Table 42. Other Amplitude Accuracy – Supplemental Information

Description	Supplemental information
RBW switching uncertainty	0.02 dB
Display scale fidelity	See dynamic accuracy specification. Specification applied to SA measurement class with user calibration between -10 dBm and -40 dBm input power and measurement between +10 dBm and -120 dBm input power.

Table 43. Spurious Response – Supplemental Information

Description	Supplemental information
Image response	Mostly eliminated. Intermittent image response may be seen when making multi-tone or modulated signal measurements.
LO related spurious	Eliminated

Table 44. Displayed Average Noise Level (DANL) at Test Ports with Low Attenuation (dBm/Hz) ¹

Port 1 and 2 (All Options) ²

Description	Specification	Typical
100 kHz to 300 kHz	--	-72
300 kHz to 1 MHz	--	-83
1 MHz to 10 MHz	--	-93
10 MHz to 100 MHz	-108	-113
100 MHz to 1 GHz	-128	-135
1 GHz to 2 GHz	-144	-146
2 GHz to 5 GHz	-141	-145
5 GHz to 10 GHz	-140	-144
10 GHz to 15 GHz	-139	-142
15 GHz to 25 GHz	-137	-140
25 GHz to 30 GHz	-135	-138
30 GHz to 35 GHz	-133	-136
35 GHz to 40 GHz	-130	-133
40 GHz to 44 GHz	-123	-128

Port 3 and 4 (Option 4K5/4K6) ³

Description	Specification	Typical
100 kHz to 300 kHz	--	-132
300 kHz to 1 MHz	--	-138
1 MHz to 10 MHz	--	-145
10 MHz to 100 MHz	-140	-147
100 MHz to 4.5 GHz	-144	-150
4.5 GHz to 6.5 GHz	-144	-149
6.5 GHz to 9 GHz	-141	-148
9 GHz to 14 GHz	-140	-146
14 GHz to 16 GHz	-137	-144
16 GHz to 20 GHz	-136	-144

Port 3 and 4 (Option 4N5/4N6/4N7) ³

Description	Specification	Typical
100 kHz to 300 kHz	--	-118
300 kHz to 500 kHz	--	-120
500 kHz to 1 MHz	--	-130
1 MHz to 10 MHz	--	-134
10 MHz to 100 MHz	-136	-142
100 MHz to 200 MHz	-144	-146
200 MHz to 3 GHz	-144	-150
3 GHz to 6.5 GHz	-144	-148

Description	Specification	Typical
6.5 GHz to 9 GHz	-142	-147
9 GHz to 17 GHz	-141	-146
17 GHz to 20 GHz	-139	-146
20 GHz to 25 GHz	-139	-143
25 GHz to 30 GHz	-136	-143
30 GHz to 44 GHz	-134	-141

1. Tested with 1 kHz RBW up to 50 MHz and 10 kHz RBW for above 50 MHz, test port terminated, average detector, averaging type = Log, IF gain = AUTO, image rejection = normal, random LO OFF.
2. With 0 dB attenuation.
3. With low attenuation.

Table 45. Displayed Average Noise Level (DANL) at Test Ports with High Attenuation (dBm/Hz)¹ - Typical

Port 1 and 2 (All Options)²

Description	Specification	Typical
100 kHz to 300 kHz	--	-47
300 kHz to 1 MHz	--	-59
1 MHz to 10 MHz	--	-69
10 MHz to 100 MHz	--	-87
100 MHz to 1 GHz	--	-110
1 GHz to 2 GHz	--	-121
2 GHz to 5 GHz	--	-119
5 GHz to 10 GHz	--	-118
10 GHz to 15 GHz	--	-117
15 GHz to 30 GHz	--	-114
30 GHz to 35 GHz	--	-113
35 GHz to 40 GHz	--	-111
40 GHz to 44 GHz	--	-103

Port 3 and 4 (Option 4K5/4K6)³

Description	Specification	Typical
100 kHz to 300 kHz	--	-110
300 kHz to 100 MHz	--	-116
100 MHz to 6.5 GHz	--	-127
6.5 GHz to 9 GHz	--	-126
9 GHz to 14 GHz	--	-124
14 GHz to 20 GHz	--	-122

Port 3 and 4 (Option 4N5/4N6/4N7)³

Description	Specification	Typical
100 kHz to 300 kHz	--	-96
300 kHz to 500 kHz	--	-98
500 kHz to 1 MHz	--	-108
1 MHz to 100 MHz	--	-112
100 MHz to 200 MHz	--	-124
200 MHz to 3 GHz	--	-128
3 GHz to 6.5 GHz	--	-126
6.5 GHz to 9 GHz	--	-125
9 GHz to 20 GHz	--	-124
20 GHz to 30 GHz	--	-121
30 GHz to 44 GHz	--	-119

1. Tested with 1 kHz RBW up to 50 MHz and 10 kHz RBW for above 50 MHz, test port terminated, average detector, averaging type = Log, IF gain = AUTO, image rejection = normal, random LO OFF.
2. With 18 dB attenuation.
3. With high attenuation.

Table 46. Second Harmonic Intercept at Test Ports (dBm) – Characteristic

Port 1 and 2 (All Options)

Description	With 0 dB Attenuation ¹	With 18 dB Attenuation ²
50 MHz to 100 MHz	47	59
100 MHz to 4 GHz	31	49
4 GHz to 6.5 GHz	28	46
6.5 GHz to 10 GHz	27	45
10 GHz to 16.5 GHz	26	44
16.5 GHz 19.5 GHz	22	40
19.5 GHz to 21.5 GHz	11	29
21.5 GHz to 22 GHz	2	20

Port 3 and 4 (Option 4K5/4K6)

Description	With Low Attenuation ³	With High Attenuation ⁴
50 MHz to 1 GHz	10	30
1 GHz to 4 GHz	20	38
4 GHz to 10 GHz	30	47

Port 3 and 4 (Option 4N5/4N6/4N7)

Description	With Low Attenuation ³	With High Attenuation ⁴
50 MHz to 1 GHz	10	30
1 GHz to 4 GHz	20	38
4 GHz to 10 GHz	30	47
10 GHz to 15 GHz	26	44
15 GHz to 20 GHz	21	40
20 GHz to 22 GHz	16	40

1. Tested with -15 dBm for 50 MHz to 150 MHz, -25 dBm for 150 MHz to 10 GHz, and -20 dBm for 10 GHz to 22 GHz input at test ports, 10 MHz tone separations.
2. Tested with 0 dBm for 50 MHz to 10 GHz, -5 dBm for 10 GHz to 22 GHz input at test ports, 10 MHz tone separations.
3. Tested with -25 dBm input at test ports, 10 MHz tone separations.
4. Tested with 0 dBm for 50 MHz to 10 GHz, -5 dBm for 10 GHz to 22 GHz input at test ports, 10 MHz tone separations.

Table 47. Second Harmonic Intercept at Direct Access Input Ports with Port 1 and 2 (dBm) – Characteristic

Port 1 and 2 (All Options)

Description	With 0 dB Attenuation ¹	With 18 dB Attenuation ²
50 MHz to 1 GHz	12	30
1 GHz to 10 GHz	16	34
10 GHz to 16.5 GHz	13	31
16.5 GHz to 19.5 GHz	10	28
19.5 GHz to 21.5 GHz	-5	13
21.5 GHz to 22 GHz	-10	8

1. Tested with -40 dBm for 50 MHz to 1 GHz, -35 dBm for 1 GHz to 22 GHz input at direct access input ports, 10 MHz tone separations. Tested high-side intermodulation only. (Ftest = f1 + f2)
2. Tested with -10 dBm input at direct access input ports, 10 MHz tone separations. Tested high-side intermodulation only. (Ftest = f1 + f2).

Table 48. Third Harmonic Distortion at Test Ports (dBc) – Characteristic

Port 1 and 2 (All Options)

Description	With 0 dB Attenuation ¹	With 18 dB Attenuation ²
50 MHz to 150 MHz	-66	-46
150 MHz to 10 GHz	-68	-58
10 GHz to 15 GHz	-64	-62
15 GHz to 25 GHz	-64	-54
25 GHz to 32 GHz	-62	-48
32 GHz to 40 GHz	-58	-48
40 GHz to 44 GHz	-56	-30

Port 3 and 4 (Option 4K5/4K6)

Description	With Low Attenuation ³	With High Attenuation ⁴
50 MHz to 200 MHz	-56	-40
200 MHz to 2 GHz	-56	-44
2 GHz to 5 GHz	-56	-46
5 GHz to 10 GHz	-52	-50
10 GHz to 15 GHz	-66	-60
15 GHz to 20 GHz	-66	-54

Port 3 and 4 (Option 4N5/4N6/4N7)

Description	With Low Attenuation ³	With High Attenuation ⁴
50 MHz to 200 MHz	-56	-40
200 MHz to 2 GHz	-56	-44
2 GHz to 5 GHz	-56	-46
5 GHz to 10 GHz	-52	-50
10 GHz to 15 GHz	-66	-56
15 GHz to 20 GHz	-66	-52
20 GHz to 30 GHz	-66	-42
30 GHz to 40 GHz	-66	-48
40 GHz to 44 GHz	-66	-52

1. Tested with -15 dBm for 50 MHz to 150 MHz, -25 dBm for 150 MHz to 10 GHz, and -20 dBm for 10 GHz to 44 GHz input at test ports, 10 MHz tone separations.
2. Tested with 0 dBm for 50 MHz to 10 GHz, -5 dBm for 10 GHz to 44 GHz input at test ports, 10 MHz tone separations
3. Tested with -25 dBm input at test ports, 10 MHz tone separations.
4. Tested with 0 dBm for 50 MHz to 10 GHz, -5 dBm for 10 GHz to 30 GHz, -10 dBm for 30 GHz to 40 GHz, and -15 dBm for 40 GHz to 44 GHz input at test ports, 10 MHz tone separations

Table 49. Third Harmonic Distortion at Direct Access Input Ports (dBc) – Characteristic

Port 1 and 2 (All Options)

Description	With 0 dB Attenuation ¹	With 18 dB Attenuation ²
50 MHz to 1 GHz	-62	-46
1 GHz to 3 GHz	-66	-52
3 GHz to 15 GHz	-66	-60
15 GHz to 25 GHz	-64	-60
25 GHz to 32 GHz	-60	-58
32 GHz to 35 GHz	-56	-58
35 GHz to 44 GHz	-56	-54

1. Tested with -40 dBm for 50 MHz to 1 GHz, -35 dBm for 1 GHz to 25 GHz, and -30 dBm for 25 GHz to 44 GHz input at direct access input ports, 10 MHz tone separations.
2. Tested with -10 dBm input at direct access input ports, 10 MHz tone separations.

**Table 50. Third Order Intermodulation Distortion at Test Ports (dBm) ¹
– Characteristic**

Port 1 and 2 (All Options)

Description	With 0 dB Attenuation ¹	With 18 dB Attenuation ²
50 MHz to 100 MHz	18	23
100 MHz to 150 MHz	18	29
150 MHz to 1 GHz	9	29
1 GHz to 10 GHz	9	29
10 GHz to 15 GHz	12	26
15 GHz to 25 GHz	12	22
25 GHz to 32 GHz	11	19
32 GHz to 35 GHz	9	19
35 GHz to 40 GHz	9	19
40 GHz to 44 GHz	8	10

Port 3 and 4 (Option 4K5/4K6)

Description	With Low Attenuation ³	With High Attenuation ⁴
50 MHz to 200 MHz	3	20
200 MHz to 2 GHz	3	22
2 GHz to 5 GHz	3	23
5 GHz to 10 GHz	1	25
10 GHz to 15 GHz	8	25
15 GHz to 20 GHz	8	22

Port 3 and 4 (Option 4N5/4N6/4N7)

Description	With Low Attenuation ³	With High Attenuation ⁴
50 MHz to 200 MHz	3	20
200 MHz to 2 GHz	3	22
2 GHz to 5 GHz	3	23
5 GHz to 10 GHz	1	25
10 GHz to 15 GHz	7	23
15 GHz to 20 GHz	7	21
20 GHz to 30 GHz	5	16
30 GHz to 40 GHz	2	14
40 GHz to 44 GHz	2	11

1. Tested with -15 dBm for 50 MHz to 150 MHz, -25 dBm for 150 MHz to 10 GHz, and -20 dBm for 10 GHz to 44 GHz input at test ports, 10 MHz tone separations.
2. Tested with 0 dBm for 50 MHz to 10 GHz, -5 dBm for 10 GHz to 44 GHz input at test ports, 10 MHz tone separations.
3. Tested with -25 dBm input at test ports, 10 MHz tone separations.
4. Tested with 0 dBm for 50 MHz to 10 GHz, -5 dBm for 10 GHz to 30 GHz, -10 dBm for 30 GHz to 40 GHz, and -15 dBm for 40 GHz to 44 GHz input at test ports, 10 MHz tone separations.

Table 51. Third Order Intermodulation Distortion at Direct Access Input Ports (dBm) – Characteristic

Port 1 and 2 (All Options)

Description	With 0 dB Attenuation ¹	With 18 dB Attenuation ²
50 MHz to 1 GHz	-9	13
1 GHz to 3 GHz	-2	16
3 GHz to 15 GHz	-2	20
15 GHz to 25 GHz	-3	20
25 GHz to 32 GHz	0	19
32 GHz to 35 GHz	-2	19
35 GHz to 44 GHz	-2	17

1. Tested with -40 dBm for 50 MHz to 1 GHz, -35 dBm for 1 GHz to 25 GHz, and -30 dBm for 25 GHz to 44 GHz input at direct access input ports, 10 MHz tone separations.
2. Tested with -10 dBm input at direct access input ports, 10 MHz tone separations

DANL and Distortion Relative to Test Port Level (dB)¹ – Nominal

Port 1 and 2 (All Options)²

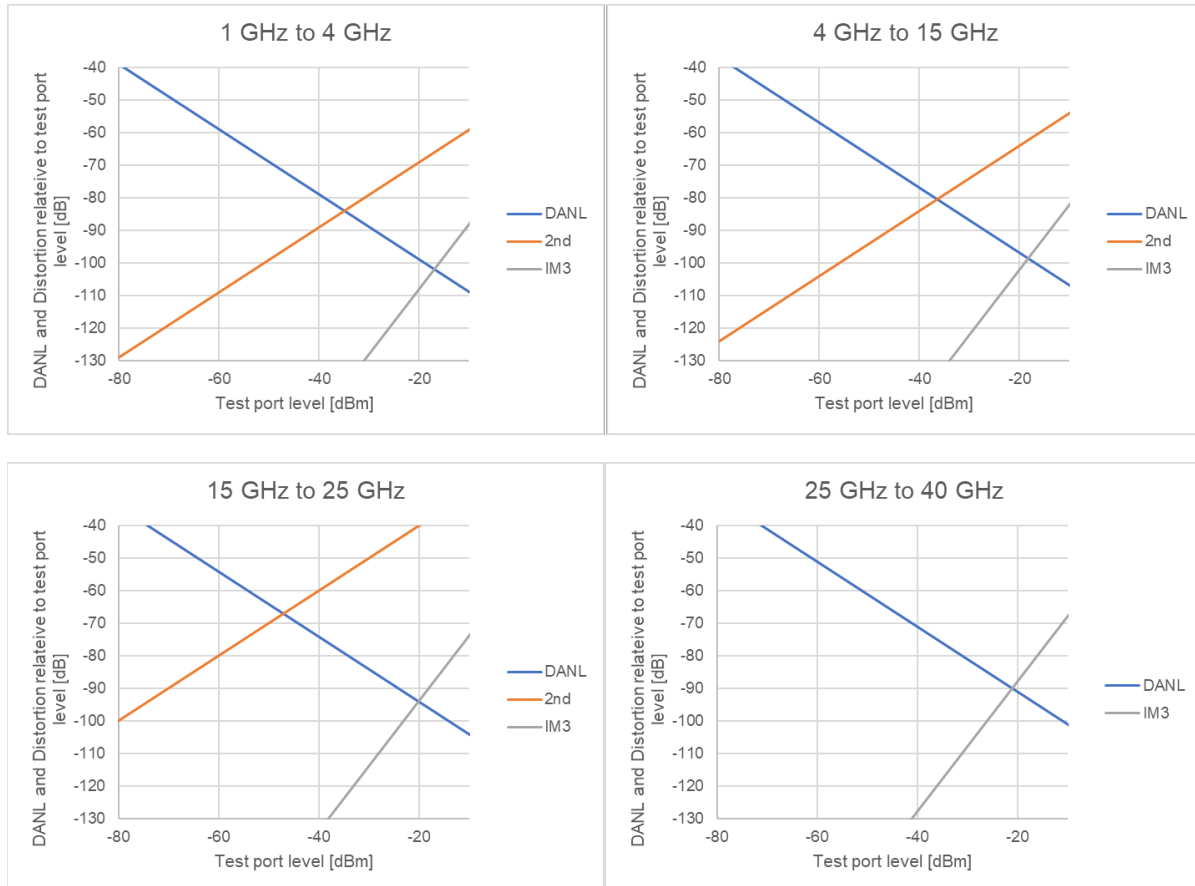

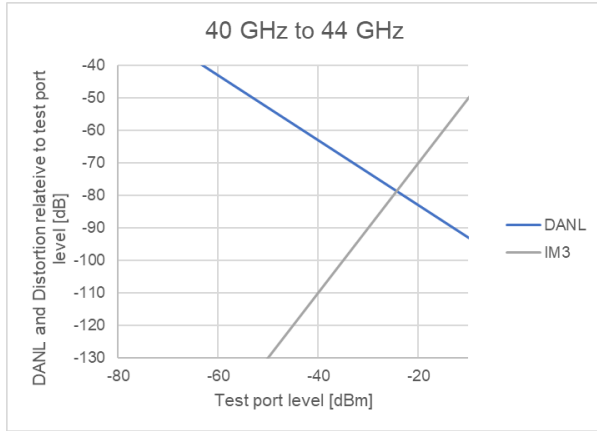

Port 3 and 4 (Option 4K5/4K6)³

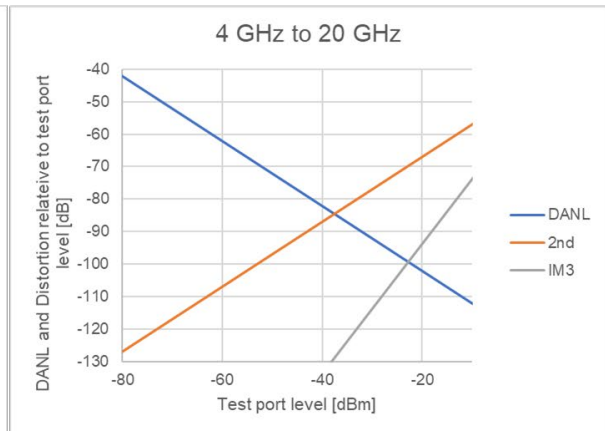
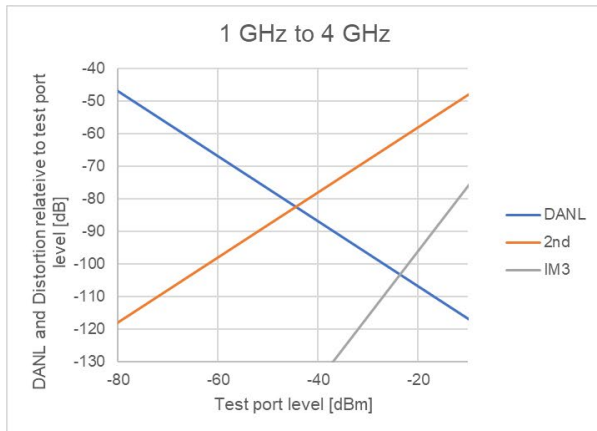

Port 3 and 4 (Option 4N5/4N6/4N7)³

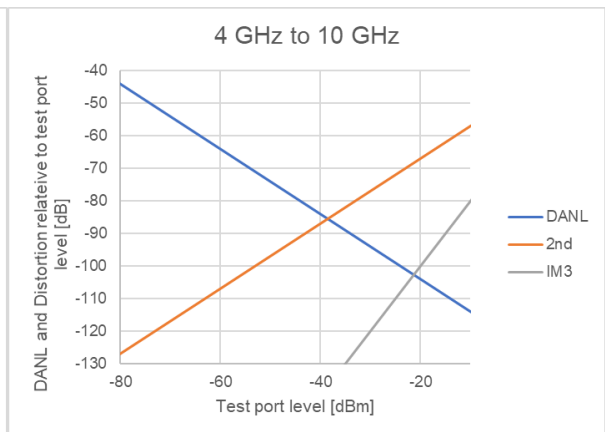
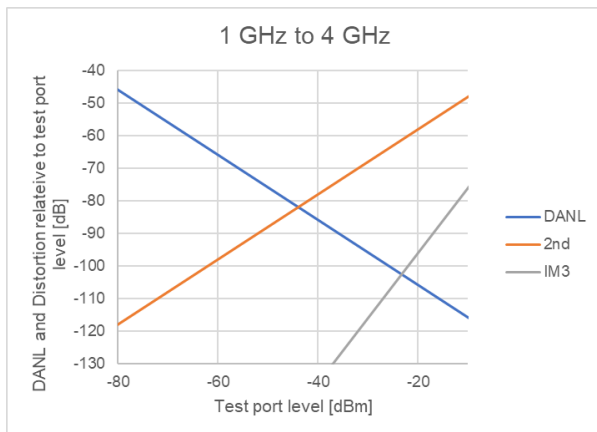

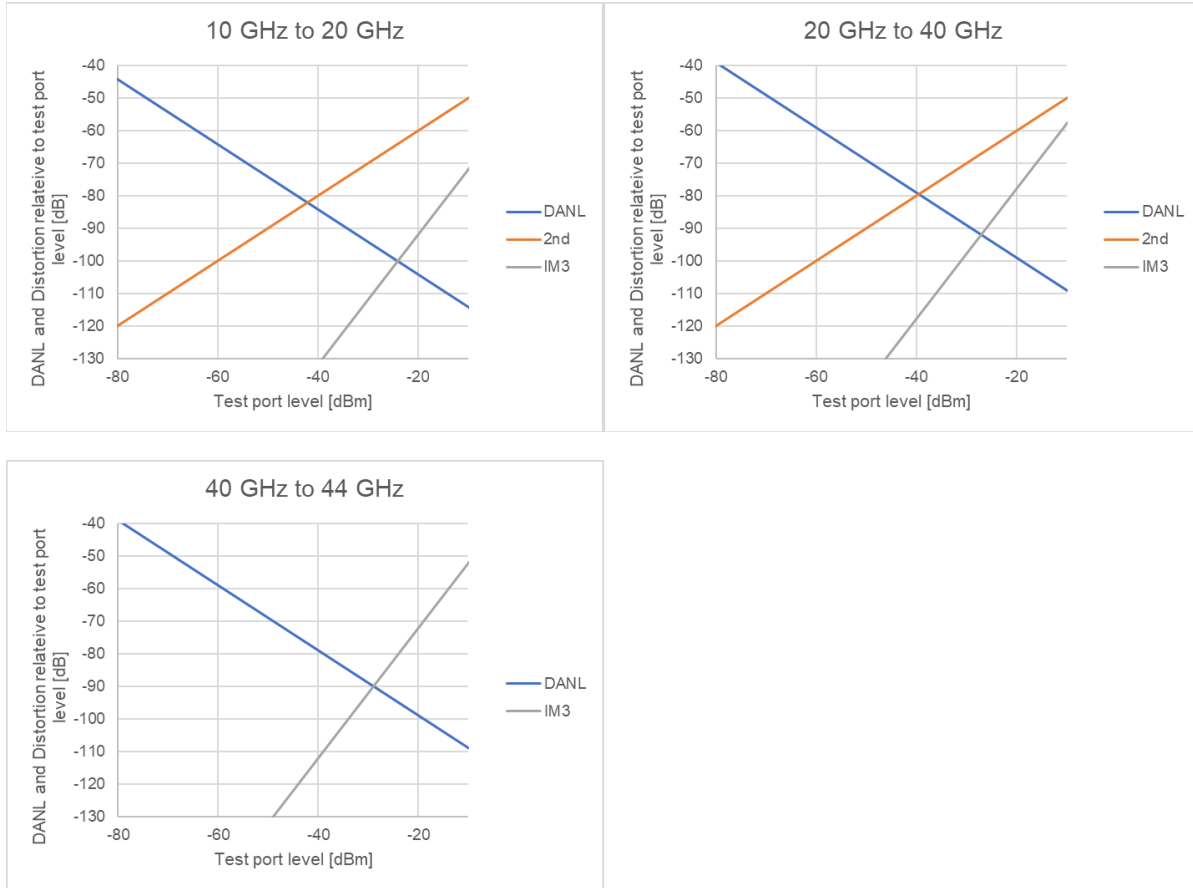

1. 2nd harmonic distortion applies up to 10 GHz (Option 2K5/2K6/4K5/4K6) or 22 GHz (Option 2N5/2N6/2N7/4N5/4N6/4N7).
2. With 18 dB attenuation.
3. With high attenuation.

Table 52. Receiver Phase Noise (dBc/Hz)¹ – Typical

Description	1 kHz	10 kHz	100 kHz	1 MHz	10 MHz
CF = 1 GHz	-103	-103	-103	-128	-130
CF = 3 GHz	-96	-96	-96	-120	-130
CF = 10 GHz	-83	-83	-83	-116	-127
CF = 20 GHz ²	-76	-76	-76	-110	-121

1. For port 1 and 2, tested with 15 dBm at 1 GHz, 3 GHz, or 10 GHz, 10 dBm at 20 GHz. For port 3 and 4, tested at maximum specified power. Spurious signals are excluded. With the SA class, phase noise of VNA's source is equivalent to the receiver phase noise.
2. Tested at 19.99 GHz.

Modulation Distortion Analysis (with S96070xB)

This section provides specifications for modulation distortion analysis using the E5081A ENA-X Option 2K6/4K6/2N6/2N7/4N6/4N7 and an external vector signal generator. The S960704B (up to 20 GHz) or S960707B (up to 44 GHz) Software is required to enable modulation analysis functions of the ENA-X. Refer to ENA and ENA-X configuration guide (literature number: [5992-3842](#)) for the list of supported signal generators by this application.

Typical measured performance (EVM and ACPR) of a thru adapter and N4985A power amp is provided.

Typical Configurations for Modulation Distortion Analysis

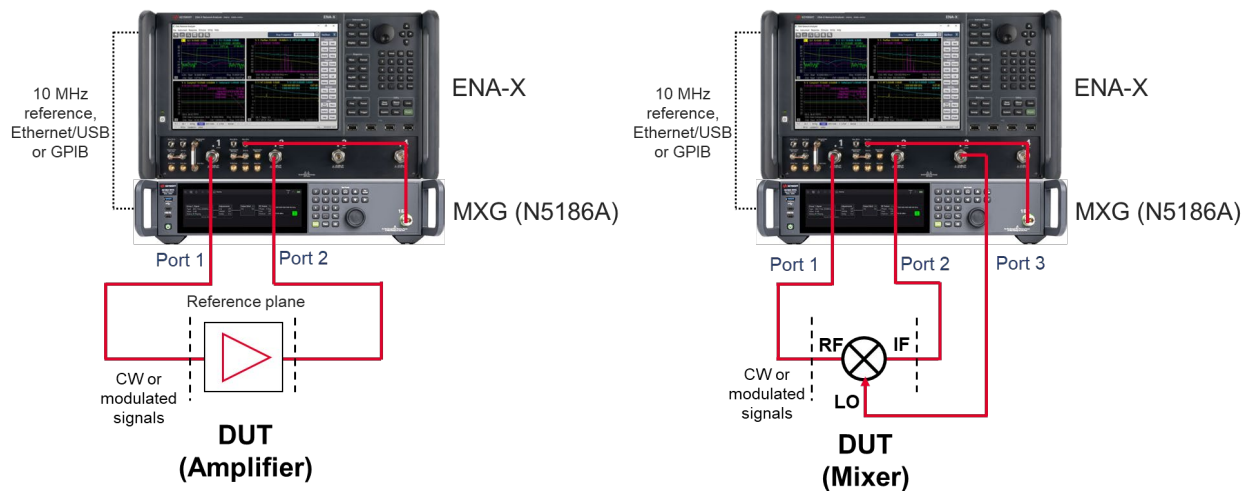

Table 53. General Information

Description	
Measurement Parameters	Error Vector Magnitude (EVM) <ul style="list-style-type: none"> Equalized EVM of the DUT (non-linear contribution) Unequalized EVM of the DUT (Includes non-linear and linear distortion due to frequency dispersion)
	Adjacent Channel Power (ACP) <ul style="list-style-type: none"> Upper and lower side bands of the input signal Upper and lower side bands of the output signal Upper and lower side bands contribution of the DUT
	Noise Power Ratio (NPR) <ul style="list-style-type: none"> Input NPR Output NPR NPR contribution of the DUT
	Band Power <ul style="list-style-type: none"> Input band power Output band power Band power gain of the DUT (magnitude and phase)

Table 54. Frequency Range – Specifications

Description	Specification
Frequency range ^{1,2}	100 MHz to 19.97 GHz (with Option 2K6/4K6)
	100 MHz to 43.97 GHz ³ (with Option 2N6/2N7/4N6/4N7)

1. Lower edge of modulated signal and upper edge of modulated signal should be within the frequency range.
2. The lowest frequency is limited by the modulation source.
3. For the carrier frequency above 41 GHz, an external bandpass filter or high-pass filter is required to avoid the measurement error due to LO leakage from the source port. Filters such as Marki P/N FH-4000 (for 41 GHz to 42 GHz) or Eravant P/N: SWF-45310360-2F2F-B1 (for 41 GHz to 43.5 GHz) are recommended. Two cascaded Keysight V281A waveguide adapters can be used as a high-pass filter for 42 GHz to 43.97 GHz.

Table 55. Maximum Modulation Bandwidth ¹ – Typical

Description	Option 2K6/2N6/4K6/4N6	Option 2N7/4N7
100 MHz to 31.8 GHz	2 GHz	2 GHz
31.8 GHz to 37 GHz	2 GHz	550 MHz
37 GHz to 44 GHz	2 GHz	2 GHz

1. The maximum modulation bandwidth is limited by the modulation source. For example, the maximum bandwidth for modulation distortion analysis is 960 MHz when used with N5186A with Option B9X (960 MHz analysis bandwidth). Use M9383A/B or M9384B for a 2 GHz bandwidth.

Table 56. Power Level Accuracy (dB) ^{1,2} – Typical

Description	Typical
100 MHz to 15 GHz	± 0.4
15 GHz to 20 GHz	± 0.6
20 GHz to 25 GHz	± 0.5
25 GHz to 30 GHz	± 0.6
30 GHz to 37.5 GHz	± 1.2
37.5 GHz to 40 GHz	± 0.8
40 GHz to 44 GHz	± 1.8

1. At -10 dBm source power
2. Without user power calibration. Power level accuracy can be improved by user power calibration.

Measured Maximum Output Power ¹

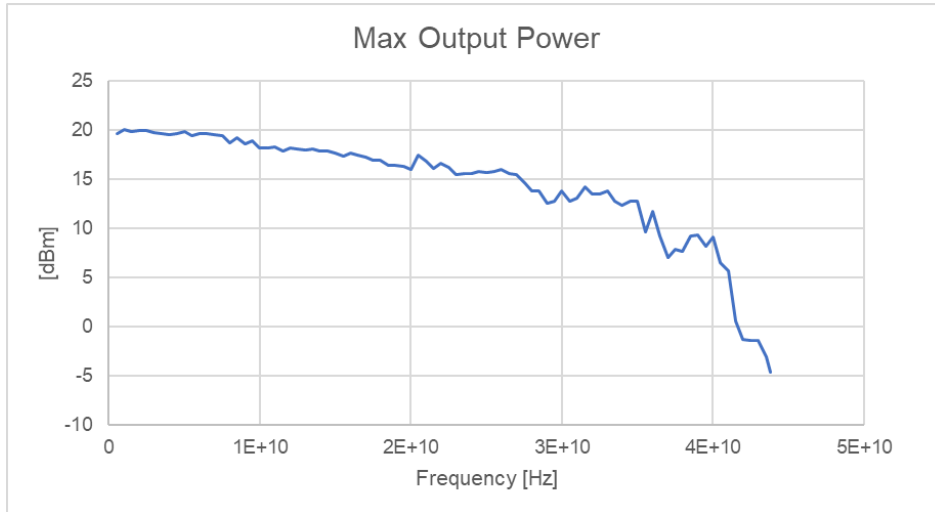

1. Flat tone modulation. 100 MHz modulation bandwidth, Random phase, 1,001 tones, PAPR = 9.486 dB.

Table 57. Settable Frequency and Power Range

Description	
Settable frequency range	100 MHz to 19.97 GHz (Option 2K6/4K6) 100 MHz to 43.97 GHz (Option 2N6/2N7/4N6/4N7)
Settable power range	-100 to +25 dBm
Settable power resolution	0.01 dB

Measured Source Output Third Order Intermodulation Distortion (IM3) ¹ – Typical

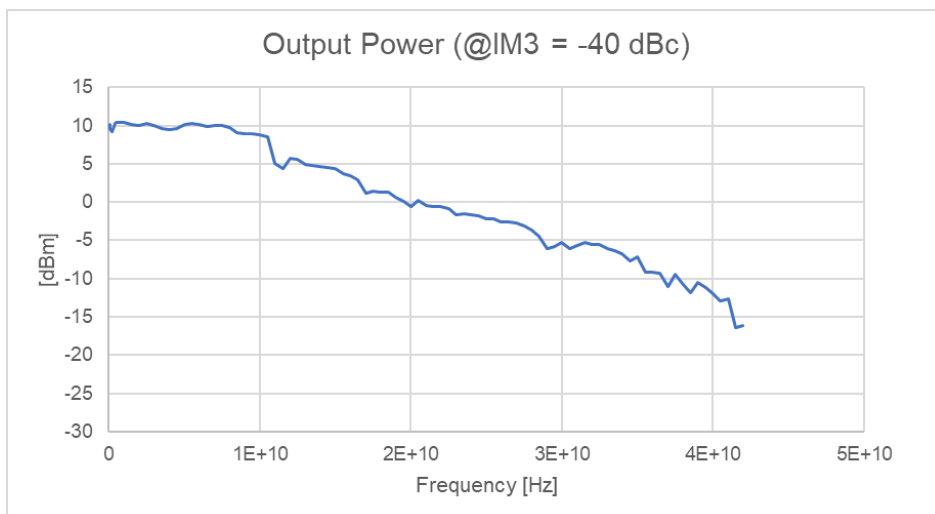

1. Measured tone power at test port 1 with -40 dBc IM3 with two-tone signals. 1 MHz tone separation, 0 dB source mixer attenuator.

Measured Adjacent Channel Power (ACP) Loopback ^{1,2} – Typical

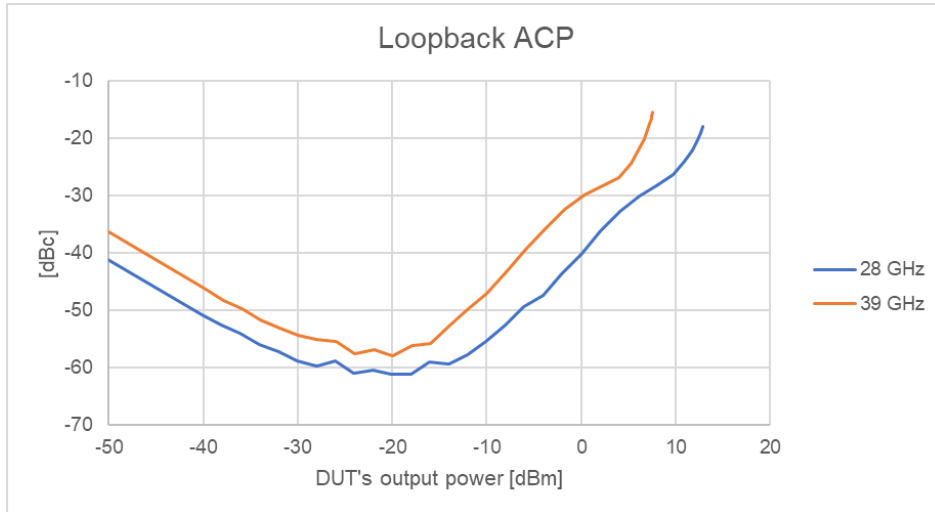

Measured Error Vector Magnitude (EVM) Loopback ^{1,2} – Typical

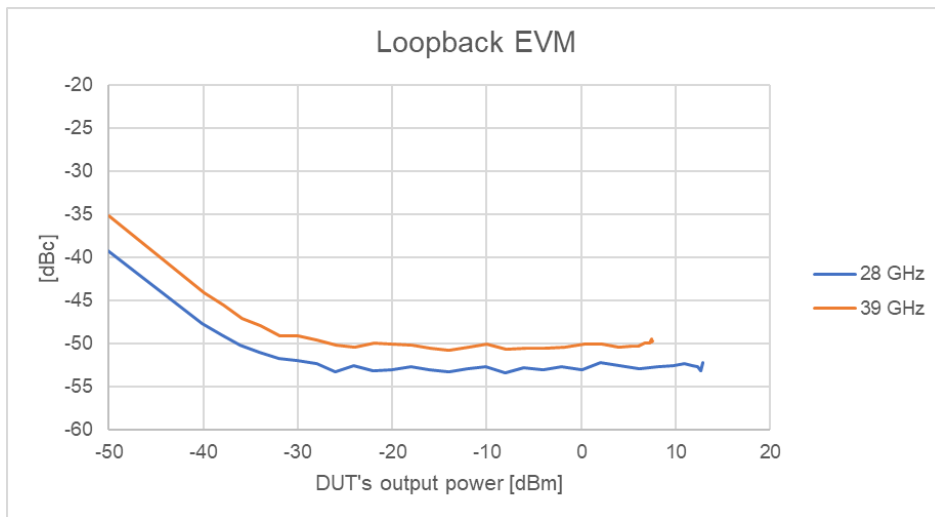

1. Measured ACP & EVM of 11900B adapter (female-female, 2.4-mm connectors) using a compact waveform of 5G NR (32 μ s period), 100 MHz bandwidth, 64QAM, 60 kHz SCS, 2,979 Number of tones.
2. 10 Hz noise bandwidth, Cal All is performed with 100 Hz noise reduction, source mixer attenuator: Auto, Receiver RF attenuator is optimized for measurement power.

Measured Adjacent Channel Power (ACP) ^{1,2} – Typical

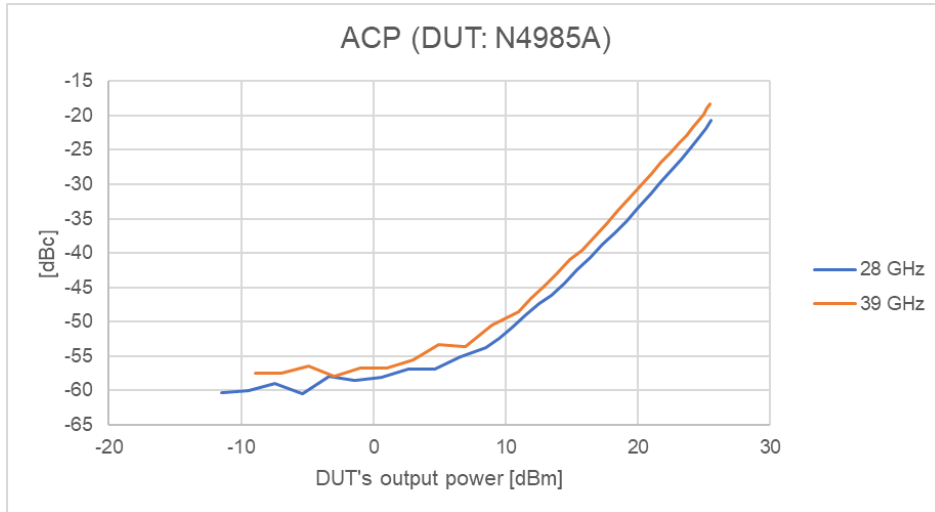

Measured Error Vector Magnitude (EVM) ^{1,2} – Typical

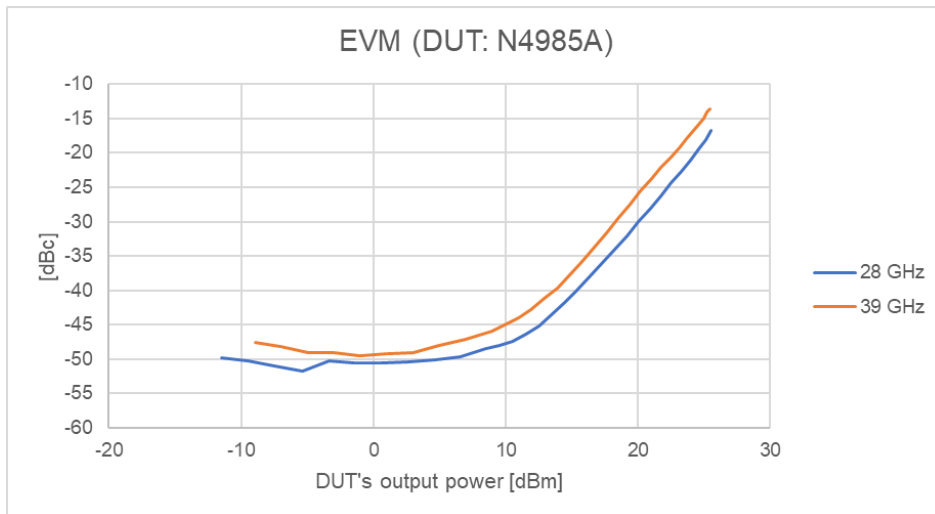

1. Measured ACP & EVM of Keysight N4985A (power amplifier, 2 GHz to 50 GHz with option P25) using a compact waveform of 5G NR (32 μ s period). 100 MHz bandwidth, 64QAM, 60 kHz SCS, 2,979 Number of tones.
2. 10 Hz noise bandwidth, Cal All is performed with 100 Hz noise reduction, source mixer attenuator: Auto, Receiver RF attenuator is optimized for measurement power.

Pulsed-RF Measurements (with S96024xB or S96025xB)

This section provides specifications for the pulse modulation on E5081A ENA-X. The S96024xB or S96025xB Software is required to enable pulsed-RF measurement functions of the ENA-X.

Table 58. Pulse Modulation On/Off Ratio (dB) – Typical

Port 1 and 2 (All Options)

Description	Typical
10 MHz to 44 GHz	80

Port 3 and 4 (Option 4K5/4K6)

Description	Normal mode	Fast mode
100 kHz to 4.5 GHz	80	50
4.5 GHz to 15 GHz	70	40
15 GHz to 20 GHz	70	35

Port 3 and 4 (Option 4N5/4N6/4N7)

Description	Normal mode	Fast mode
100 kHz to 3 GHz	80	50
3 GHz to 8 GHz	80	40
8 GHz to 20 GHz	80	38
20 GHz to 40 GHz	70	30
40 GHz to 44 GHz	70	25

Pulse Modulation Shape Examples

Port 1 and 2 (All Options)

1 GHz to 20 GHz¹

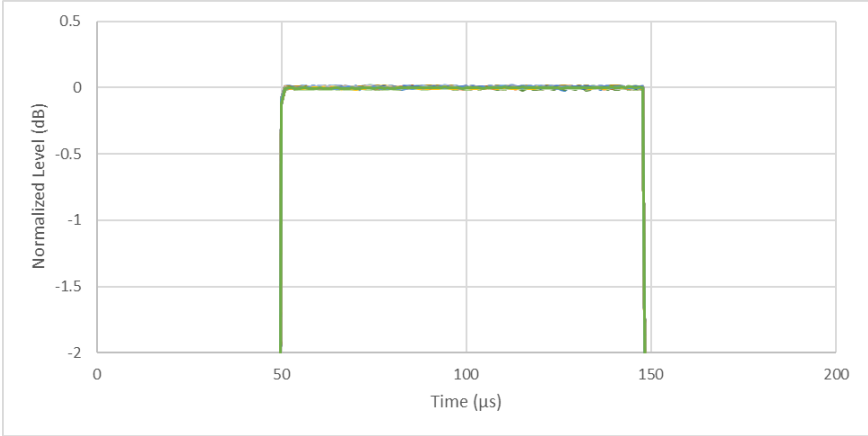

20 GHz to 44 GHz¹

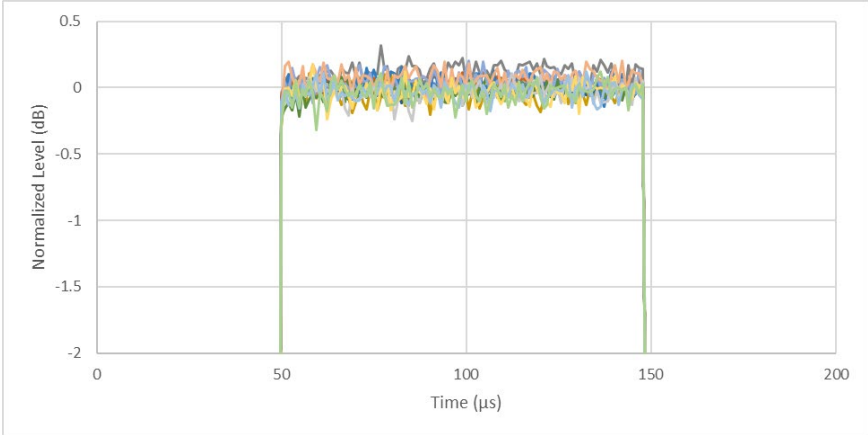

1. Measured with a 500 kHz IF bandwidth, no averaging. With 100 μs pulse width setting. 50 μs/div.

1 GHz to 20 GHz²

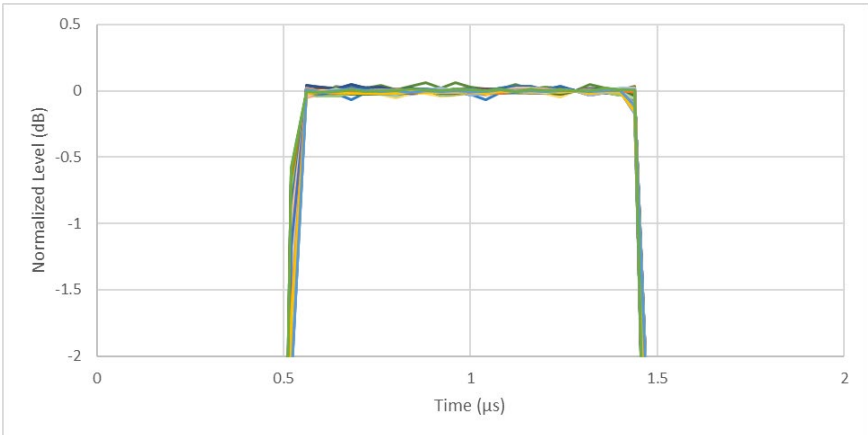

20 GHz to 44 GHz²

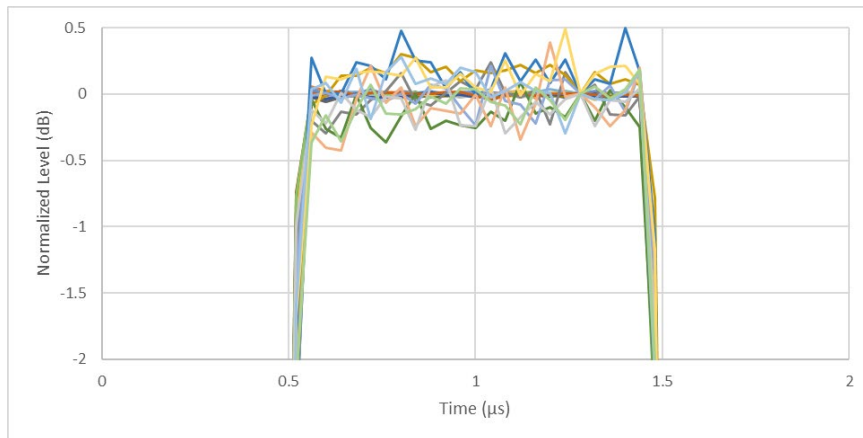

2. Measured with a 15 MHz IF bandwidth, averaging factor of 16 (Average Type = Point). With 1 μs pulse width setting. 0.5 μs/div. S960250B software is required. (Minimum pulse width with S960240B is 50 μs.)

Port 3 and 4 (Option 2K5/2K6/4K5/4K6)

1 GHz to 20 GHz¹

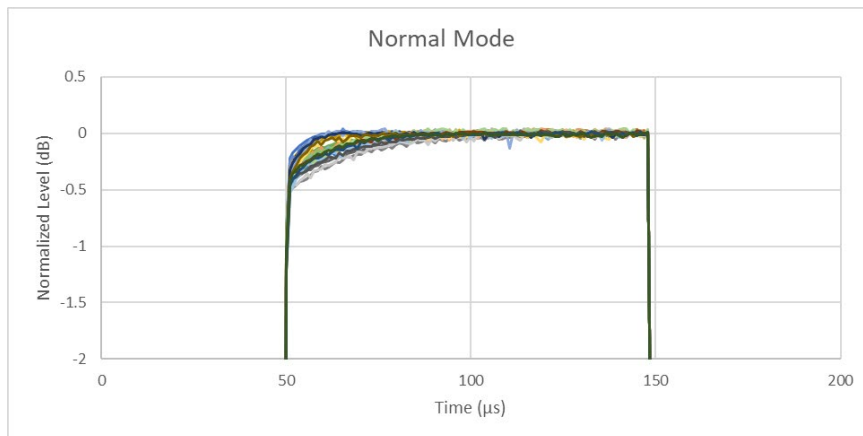

1. Measured with a 500 kHz IF bandwidth, no averaging. With 100 μs pulse width setting. 50 μs/div.

1 GHz to 20 GHz²

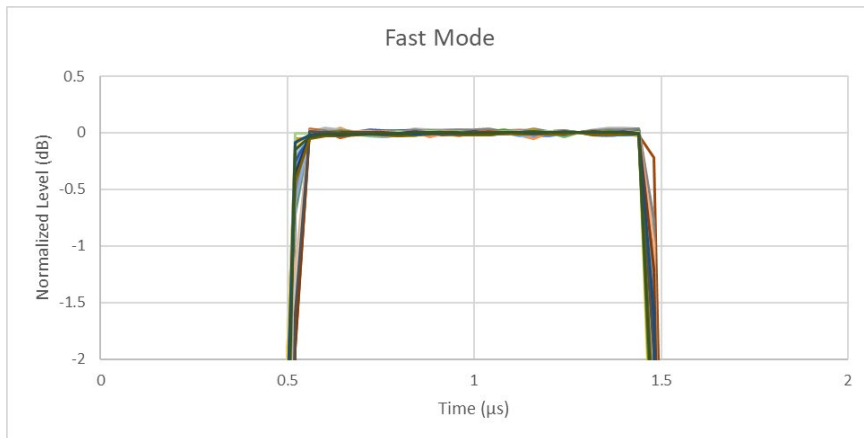

2. Measured with a 15 MHz IF bandwidth, averaging factor of 16 (Average Type = Point). With 1 μs pulse width setting. 0.5 μs/div. S960250B software is required. (Minimum pulse width with S960240B is 50 μs.)

Port 3 and 4 (Option 2N5/2N6/2N7/4N5/4N6/4N7)

1 GHz to 26.5 GHz¹

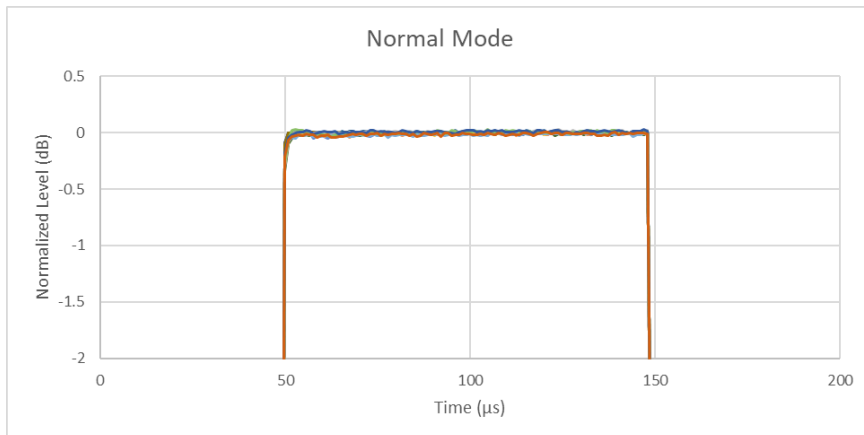

32 GHz¹

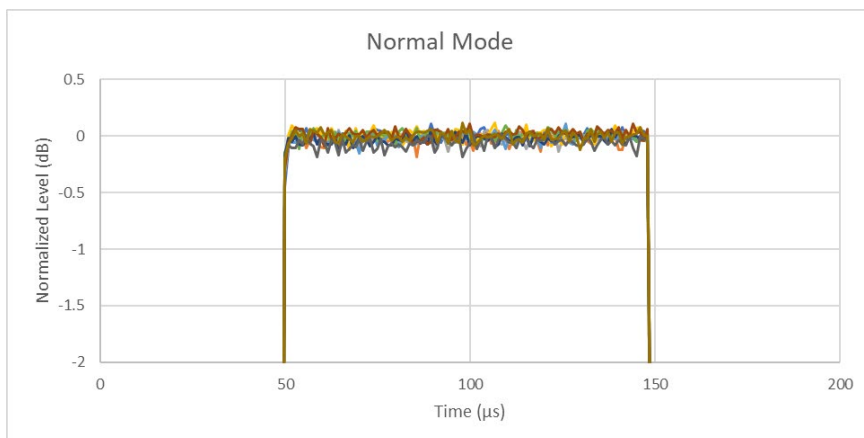

44 GHz¹

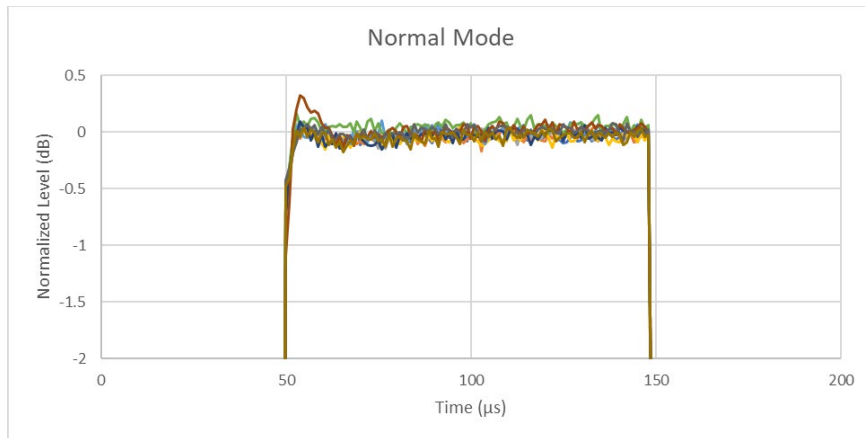

1. Measured with a 500 kHz IF bandwidth, no averaging. With 100 μs pulse width setting. 50 μs/div

1 GHz to 26.5 GHz²

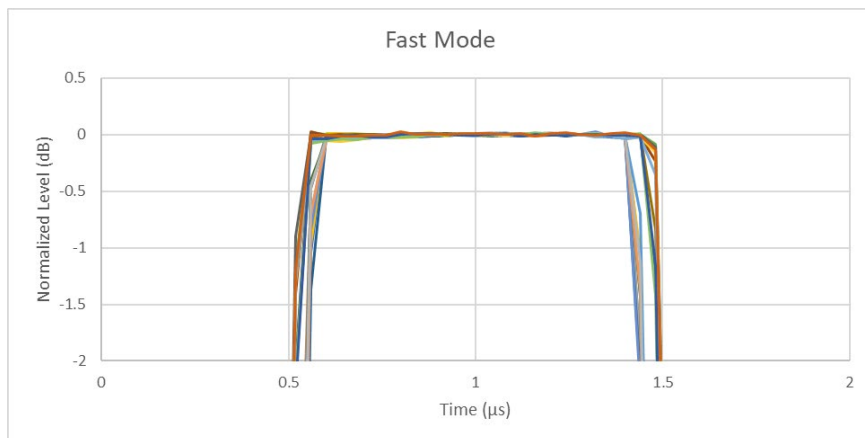

32 GHz²

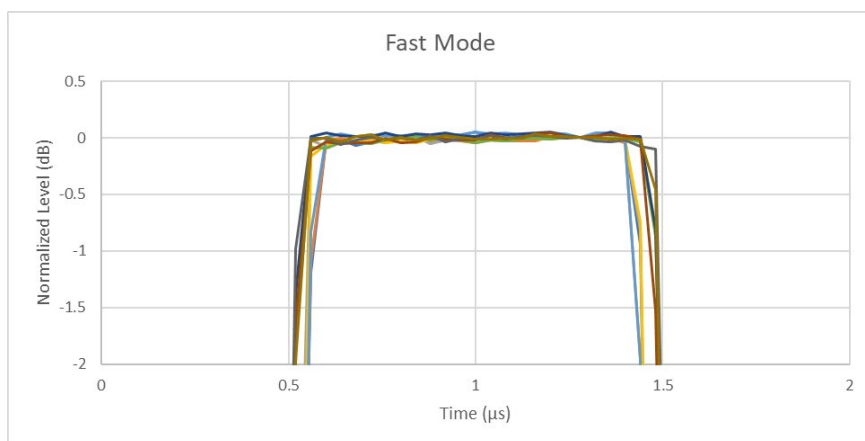

44 GHz²

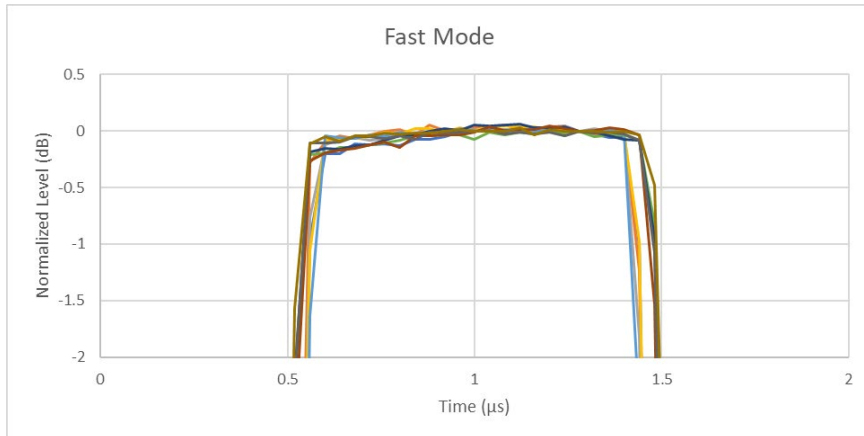

2. Measured with a 15 MHz IF bandwidth, averaging factor of 16 (Average Type = Point). With 1 μs pulse width setting, 0.5 μs/div. S960251B software is required. (Minimum pulse width with S960241B is 50 μs.)

Table 59. Pulse Modulation (Source Modulators) – Typical

Description	Typical
Minimum pulse width	200 ns
Minimum pulse period	1 μs
Maximum pulse period	10 s

Enhanced Time Domain Analysis with TDR (with S96011B)

This section provides specifications for the enhanced time domain analysis on the E5081A ENA-X. The S96011B Software is required to enable enhanced time domain analysis functions of the ENA-X.

Table 60. Key Specifications of Enhanced Time Domain Analysis

Description		Option 2N5/2N6/2N7/4N5/4N6/4N7	Option 2K5/2K6/4K5/4K6
Bandwidth	Spec.	44 GHz	20 GHz
Input impedance	Nom.	50 Ω	50 Ω
DC damage level at test port	Spec.	35 V	35 V
Maximum test port input voltage (Hot TDR mode)	Typ.	1.5 Vpp (10 MHz to 20 GHz) 0.9 Vpp (20 GHz to 30 GHz) 0.7 Vpp (30 GHz to 40 GHz) 0.5 Vpp (40 GHz to 44 GHz)	1.5 Vpp
TDR stimulus ¹	Nom.	Step, Impulse	Step, Impulse
TDR step amplitude ²	Nom.	1 mV to 5 V	1 mV to 5 V
TDR step rise time ³ (min) (10% to 90%)	Spec.	10.2 ps	22.3 ps
TDR step response resolution in free space ⁴ (εr = 1) (min)	Nom.	1.5 mm	3.3 mm
TDR impulse width (min) ³	Spec.	13.8 ps	30.2 ps
TDR deskew range (max) ⁵ (test cable length)	Typ.	12.5 ns	12.5 ns
DUT length (max) ⁶	Spec.	12.5 ns	12.5 ns
TDR stimulus repetition rate (max)	Spec.	43.9 MHz	19.9 MHz
RMS noise level ⁷	Typ.	110 μVrms	110 μVrms
Eye diagram data rate (max) ⁸	Spec.	35.2 Gb/s	16 Gb/s

1. The time domain function of the S96011B is similar to the time domain reflectometry (TDR) measurement on a TDR oscilloscope in that it displays the response in the time domain. In the TDR oscilloscope measurement, a pulse or step stimulus is input to the DUT and the change of the reflected wave over time is measured. In the S96011B TDR measurement, a sine wave stimulus is input to the DUT and the change of the reflected wave over frequency is measured. Then, the frequency domain response is transformed to the time domain using the Inverse Fourier Transform.
2. The TDR step amplitude setting does not vary the actual stimulus level input to the device but is used when calculating the Inverse Fourier Transform.
3. Minimum values may be limited by the DUT length setting.
4. To convert from rise time to response resolution, multiply the rise time by c, the speed of light in free space. To calculate the actual physical length, multiply this value in free space by vf, the relative velocity of propagation in the transmission medium. (Most cables have a relative velocity of 0.66 for a polyethylene dielectric or 0.7 for a PTFE dielectric.)
5. Using high quality cables to connect the DUT is recommended in order to minimize measurement degradation. The cables should have low loss, low reflections, and minimum performance variation when flexed.
6. Maximum DUT length is the sum of the DUT and test cable lengths. Settable DUT length (max) is 1.25 μs.
7. RMS noise level with 50 Ω DUT and default setup.
8. Maximum values may be limited by the DUT length setting.

General Information

Table 61. Miscellaneous Information

Description	Specification
System IF bandwidth range	1 Hz to 15 MHz
Number of points	1 to 100,003
Operating System	Windows 10 (Supports both 32-bit and 64-bit applications)

Table 62. Front Panel Information

Description	Specification
Test Port	
Connector type	3.5 mm male (Option 2K5/2K6/4K5/4K6) 2.4 mm male (Option 2N5/2N6/2N7/4N5/4N6/4N7)
Impedance	50 Ω (nominal)
Direct Receiver Access Input (Rcvr A In, Rcvr B In, Rcvr R1 In, Rcvr R2 In)	
Connector type	3.5 mm female (Option 2K5/2K6/4K5/4K6) 2.4 mm female (Option 2N5/2N6/2N7/4N5/4N6/4N7)
Impedance	50 Ω (nominal)
Source Output (Src1 Out, Src2 Out)	
Connector type	SMA
Impedance	50 Ω (nominal)
Upconverter BBnd In	
Connector type	SMA
Impedance	50 Ω (nominal)
Upconverter RF Input (RF In)	
Connector type	SMA
Impedance	50 Ω (nominal)
Upconverter RF Output (Upconverter RF1 Out, Upconverter RF2 Out)	
Connector type	3.5 mm female (Option 2K6/4K6) 2.4 mm female (Option 2N5/2N6/2N7/4N5/4N6/4N7)
Impedance	50 Ω (nominal)
Source Input (Src1 In, Src2 In)	
Connector type	3.5 mm female (Option 2K6/4K6) 2.4 mm female (Option 2N5/2N6/2N7/4N5/4N6/4N7)
Impedance	50 Ω (nominal)
IF Out (IF A Out, IF B Out, IF R1 Out, IF R2 Out)	
Connector type	SMA
Impedance	50 Ω (nominal)
USB ports	
Standard	Compatible with USB 2.0
Connector	USB Type-A female

Description	Specification
Display	
Size	31 cm (12.1 inch) diagonal color active matrix LCD with multi-touch screen
Resolution	1280 (horizontal) X 800 (vertical) resolution ¹

1. Valid pixels are 99.99% and more. Below 0.02% of fixed points of black, blue, green or red are not regarded as failure.

Table 63. Side Panel Information

Description	Specification
Display output	DisplayPort and VGA (supports up to two simultaneous displays)
GPIB (Option 172)	24-pin D-Sub (Type D-24), female; compatible with IEEE-488
USB ports	Four USB ports, one USB device port ¹
LAN	Two Gigabit Ethernet, RJ-45 LAN ports

1. USB Test and Measurement Class (TMC) interface that communicates over USB, complying with the IEEE 488.1 and IEEE 488.2 standards.

Table 64. Rear Panel Information

Description	Specification
External trigger input	
Connector	BNC female
Input level	Low threshold voltage: 0.5 V, High threshold voltage: 2.1 V. Input level range: 0 to +5 V.
Pulse width	≥ 2 μs
Polarity	Positive or negative
External trigger output / Meas trig ready output	
Connector	BNC female
Maximum output current	50 mA
Output level	Low level voltage: 0 V, High level voltage: 5 V
Pulse width	1 μs (External Trigger Output only)
Polarity	Positive or negative
External reference input – Typical	
Connector	BNC female
Input frequency	10 MHz ± 10 ppm
Input level	-3 to +10 dBm
Input impedance	50 Ω (nominal)
Internal reference output – Typical	
Connector	BNC female
Output frequency	10 MHz ± 7 ppm
Output level	0 dBm ± 3 dB into 50 Ω
Output impedance	50 Ω (nominal)
Internal reference signal oven (Option 1E5) – Typical	
Connector	BNC female

Description	Specification
Output frequency	10 MHz \pm 0.45 ppm
Output level	0 dBm minimum
Application I/O port	
Connector	15-pin D-sub connector (female), Provides access to pulse modulators and generators
Device test I/O port	
Connector	25-pin D-sub connector (female), Provides serial and parallel digital signals for controlling device under test. Two independent 8-bit I/O
Power Supply (VIO1, VIO2)	
Output voltage	+0.9 to +3.5 V, 0.05 V step
Voltage accuracy	\pm 5 %
Maximum output current	100 mA/group
Input signal	
Input voltage range	0 V to VIO (V)
Minimum high-level input voltage	+2.0V (at VIO = +3.3 V), +1.17 V (at VIO = +1.8 V) +0.78 V (at VIO = +1.2 V)
Maximum high-level input voltage	+0.8 V (at VIO = +3.3 V), +0.63 V (at VIO = +1.8 V) +0.42 V (at VIO = +1.2 V)
Output signal	
Minimum high-level input voltage	VIO – 0.1 V (at I _o = -100 μ A)
Maximum high-level input voltage	+0.1 V (at I _o = 100 μ A)
Handler I/O port	
Connector	36-pin Centronics, female; provides connection to handler system
Line power	
Frequency, voltage	50/60 Hz for 100 to 240 VAC
Maximum power	350 W
Typical power consumption ¹	153 W (Option 2K5/2K6)
	217 W (Option 4K5/4K6)
	179 W (Option 2N5/2N6/2N7)
	216 W (Option 4N5/4N6/4N7)

1. At preset.

Table 65. AUX Input and Output Information (Option 175)

Description	Specification	Typical
AUX input		
Number of ports		4
Connector type		BNC female
Input voltage range		\pm 10 V
Damage voltage level		\pm 15 V
Accuracy ¹	1% \pm 10 mV	

Description	Specification	Typical
AUX output		
Number of ports		2
Connector type		BNC female
Output voltage range		± 10 V
Output voltage resolution		5.4 mV
Output voltage accuracy ²	$1\% \pm 20$ mV	
Maximum output current	± 200 mA	

1. When IF Bandwidth is set to ≥ 300 kHz.

2. The specification does not meet when current overload occurs.





Table 66. Environmental and Physical Specifications

Description		
Description	<p>Samples of this product have been type tested in accordance with the Keysight Environmental Test Manual and verified to be robust against the environmental stresses of Storage, Transportation and End-use; those stresses include, but are not limited to, temperature, humidity, shock, vibration, altitude, and power line conditions.</p> <p>Test Methods are aligned with IEC 60068-2 and levels are similar to MIL-PRF-28800F Class 3.</p>	
Temperature	Operating	0 to 40 °C ambient
	Non-operating	-10 to 60 °C
Humidity	Operating	Type tested at 20 to 80 %, wet bulb temperature < 29 °C (non-condensing)
	Non-operating	Type tested at 20 to 90 %, wet bulb temperature < 40 °C (non-condensing)
Altitude	Operating	Up to 2,000 meters (6,561 feet)
	Non-operating	Up to 4,572 meters (15,000 feet)
Vibration	Operating	0.21 G maximum, 5 Hz to 500 Hz
	Non-operating	0.5 G maximum, 5 Hz to 500 Hz
Instrument protection	IP 30 IEC/EN 60529	
Warm-up time	90 minutes	

Table 67. Regulatory and Safety Compliance

EMC¹

Complies with the essential requirements of the European EMC Directive as well as current editions of the following standards (dates and editions are cited in the Declaration of Conformity).



	<p>The CE mark is a registered trademark of the European Community (if accompanied by a year, it is the year when the design was proven). This product complies with all relevant directives.</p> <ul style="list-style-type: none"> • IEC 61326-1 <p>CISPR 11 Group 1, Class A</p>		
	<p>UK conformity mark is a UK government owned mark. When affixed to the product is declaring all applicable Directives and Regulations have been met in full.</p>		
<p>CAN ICES/NMB-001(A)</p>	<p>This ISM device complies with Canadian ICES-001. Cet appareil ISM est conforme a la norme NMB du Canada.</p>		
	<p>The RCM mark is a registered trademark of the Australian Communications and Media Authority. AS/NZS CISPR 11</p>		
	<p>South Korean Certification (KC) mark; includes the marking's identifier code: R-R-Kst-WN22859</p>		
	<p>South Korean Class A EMC declaration: Information to the user: This equipment has been conformity assessed for use in business environments. In a residential environment this equipment may cause radio interference. ※ This EMC statement applies to the equipment only for use in business environment.</p>		
	<table border="1" style="width: 100%;"> <tr> <td style="background-color: #e1eef6; text-align: center;">사용자 안내문</td> </tr> <tr> <td>이 기기는 업무용 환경에서 사용할 목적으로 적합성평가를 받은 기기로서 가정용 환경에서 사용하는 경우 전파간섭의 우려가 있습니다.</td> </tr> </table>	사용자 안내문	이 기기는 업무용 환경에서 사용할 목적으로 적합성평가를 받은 기기로서 가정용 환경에서 사용하는 경우 전파간섭의 우려가 있습니다.
사용자 안내문			
이 기기는 업무용 환경에서 사용할 목적으로 적합성평가를 받은 기기로서 가정용 환경에서 사용하는 경우 전파간섭의 우려가 있습니다.			
	<p>※ 사용자 안내문은 “업무용 방송통신기자재”에만 적용한다.</p>		
<p>Instrument calibration cycle</p>	<p>1 year</p>		

Safety¹

Complies with the essential requirements of the European Low Voltage Directive as well as current editions of the following standards (dates and editions are cited in the Declaration of Conformity).

This product is designed for use in INSTALLATION CATEGORY II and POLLUTION DEGREE 2 and MEASUREMENT CATEGORY NONE per IEC standards.

This product is intended for indoor use.

	<ul style="list-style-type: none"> • IEC/EN 61010-1
	<p>The CSA mark is a registered trademark of the CSA International.</p> <ul style="list-style-type: none"> • Canada: CSA C22.2 No. 610610-1 • USA: UL std no. 61010-1

1. To find a current Declaration of Conformity for a specific Keysight product, go to: <http://www.keysight.com/go/conformity>

Table 68. Physical Size and Weight

Description	Characteristics
Weight	16.7 kg (Option 2K5)
	17.4 kg (Option 2K6/2N5/2N6/2N7)
	17.4 kg (Option 4K5)
	18.3 kg (Option 4K6/4N5/4N6/4N7)

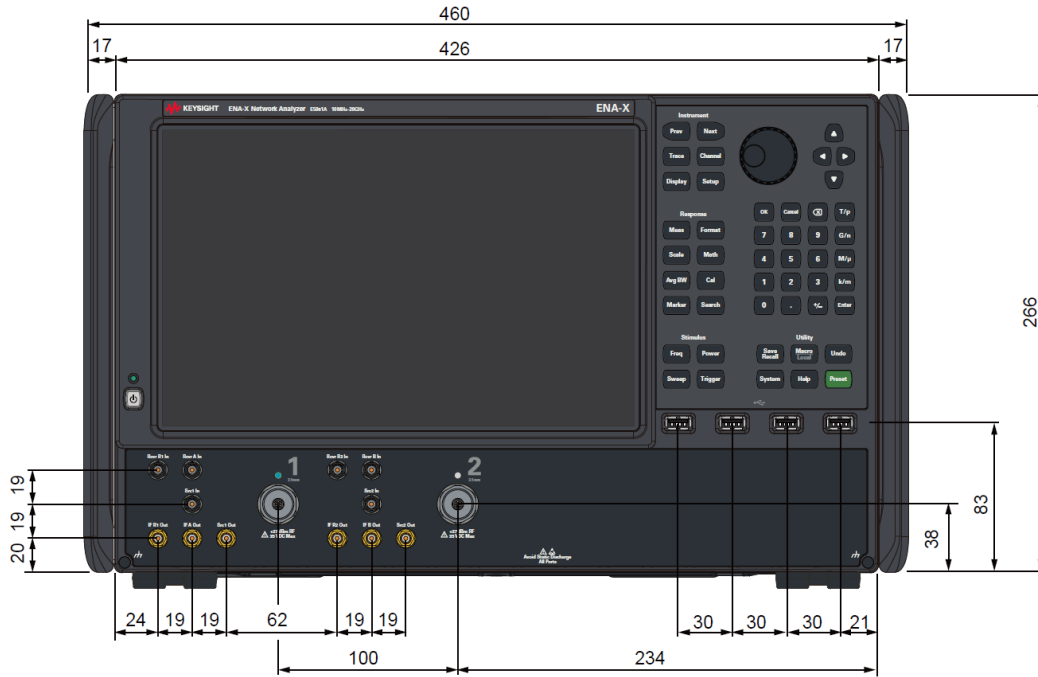

Dimensions (front view, E5081A with option 2K5, in millimeters)

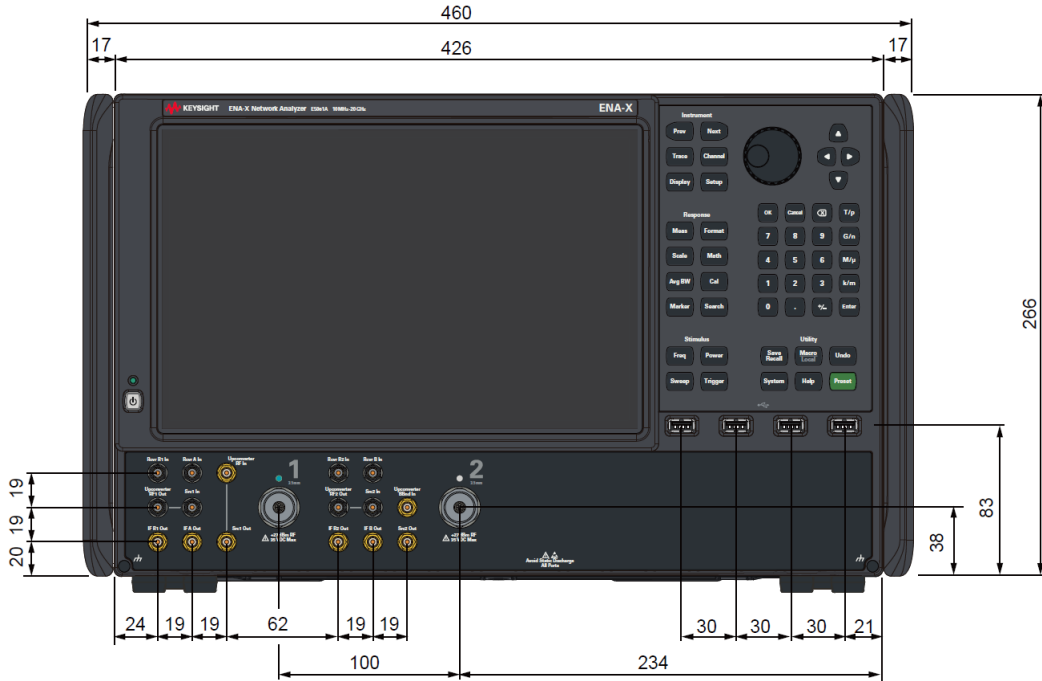

Dimensions (front view, E5081A with option 2K6, in millimeters)

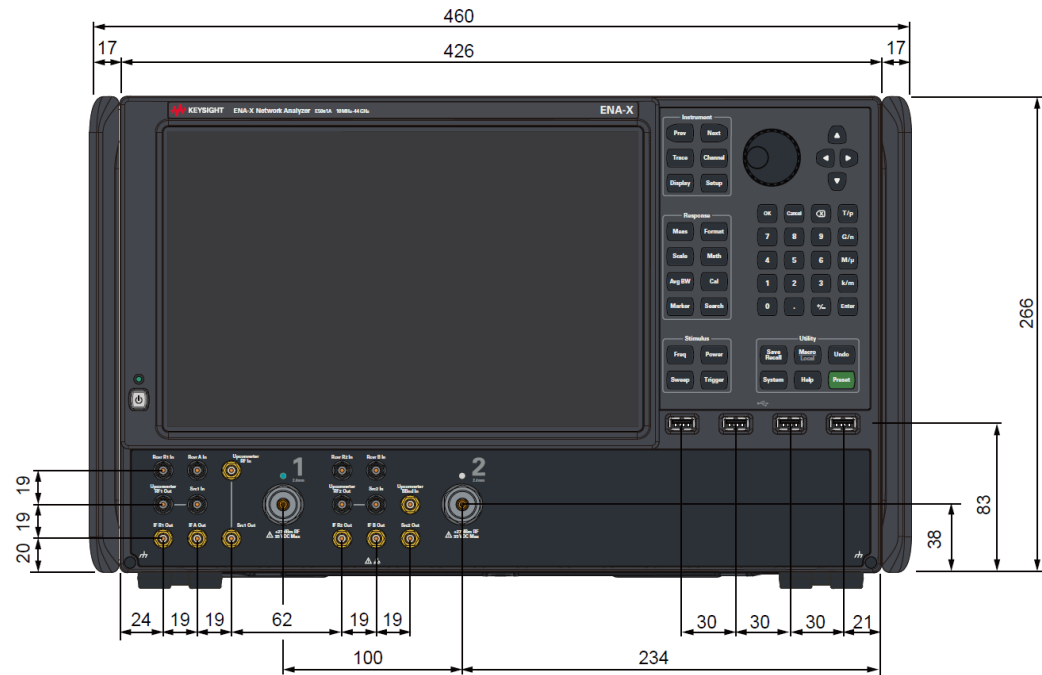

Dimensions (front view, E5081A with option 2N5/2N6/2N7, in millimeters)

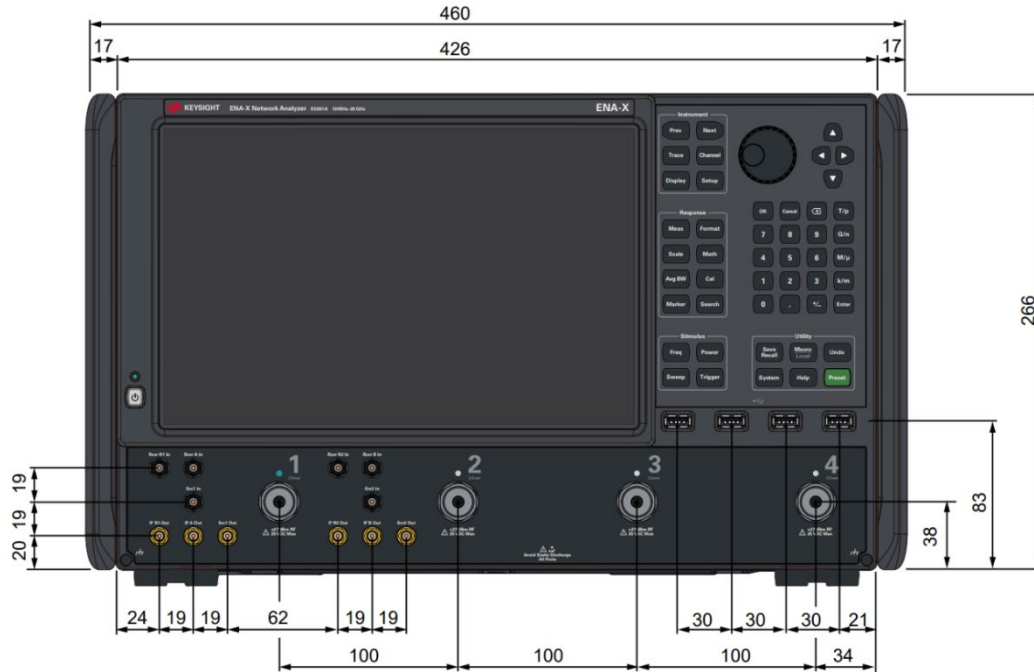

Dimensions (front view, E5081A with option 4K5, in millimeters)

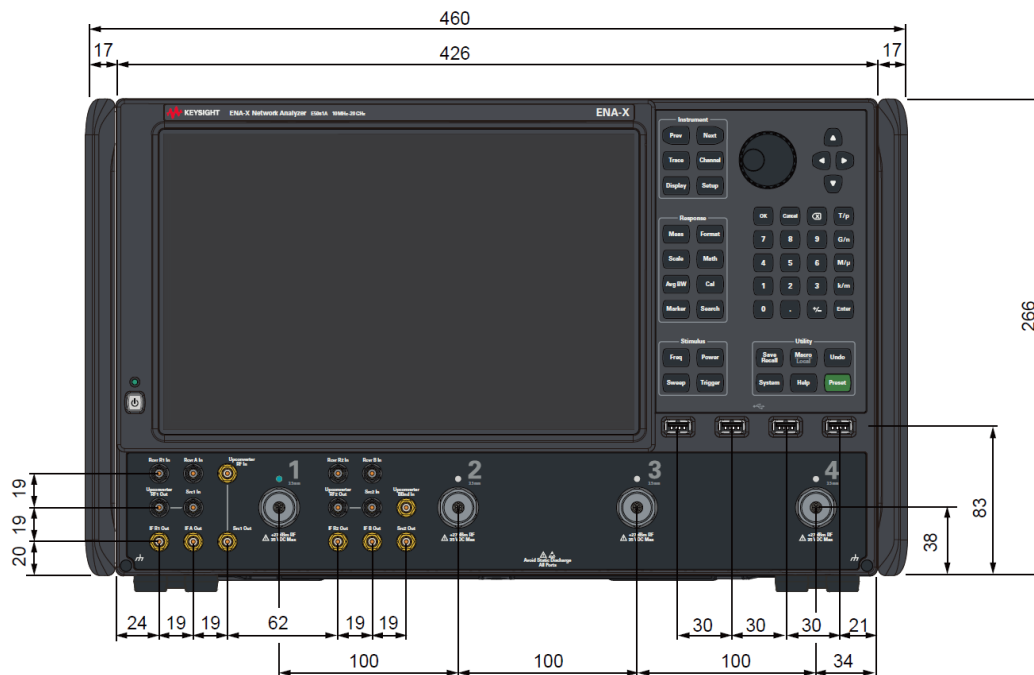

Dimensions (front view, E5081A with option 4K6, in millimeters)

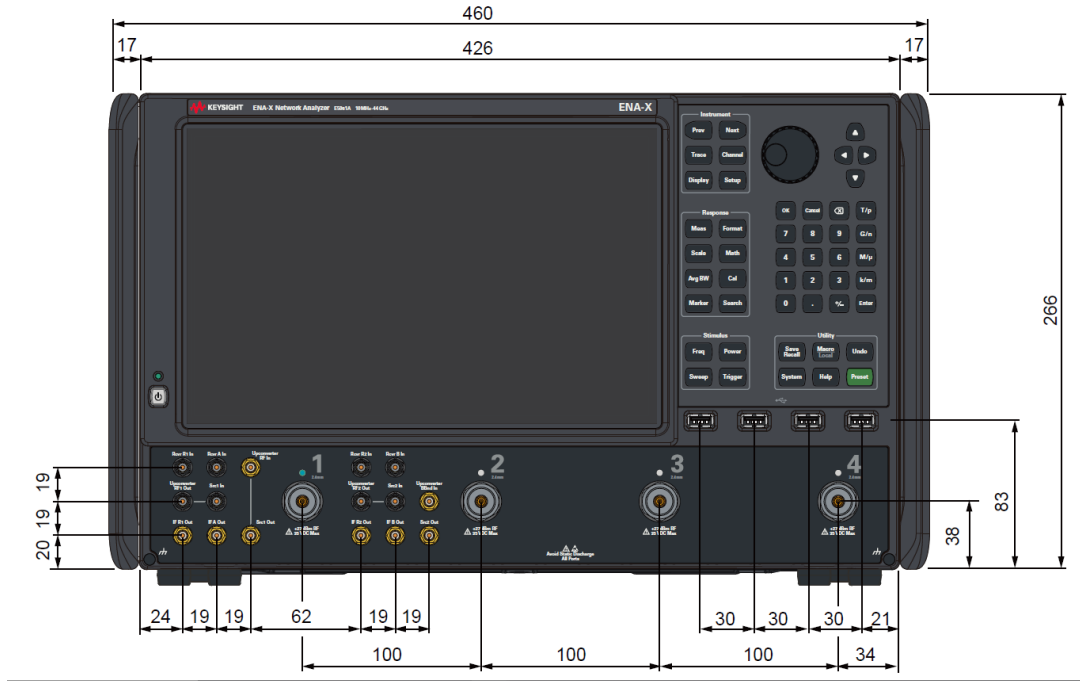

Dimensions (front view, E5081A with option 4N5/4N6/4N7, in millimeters)

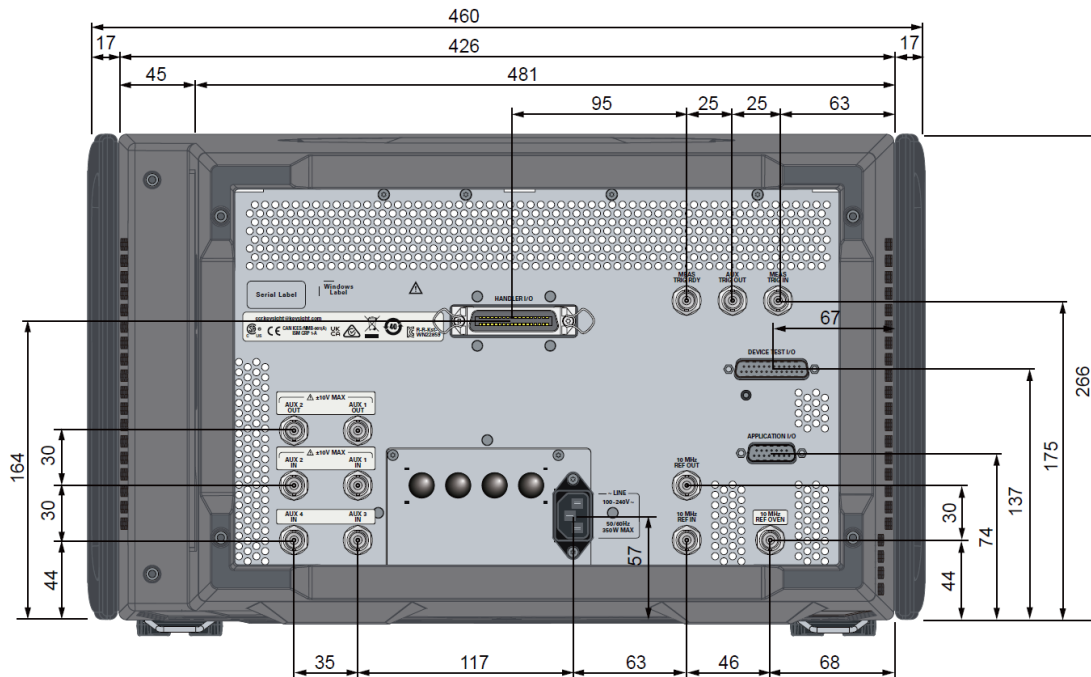

Dimensions (rear view, E5081A with option 1E5/175, in millimeters)

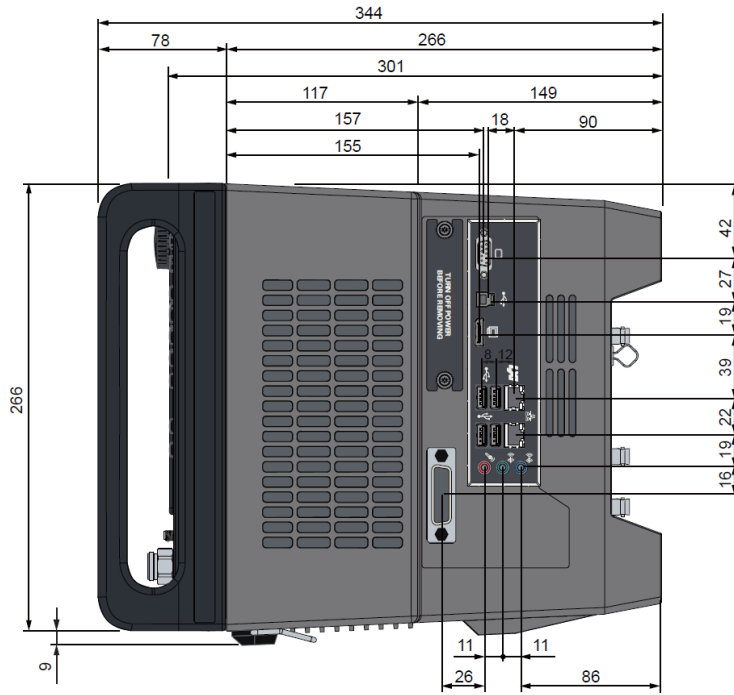

Dimensions (side view, E5081A with option 172, in millimeters)

Measurement Throughput

Table 69. Cycle Time for Measurement Completion (milliseconds) ¹ – Typical

Description	Sweep mode: Auto			Sweep mode: Stepped		
9 GHz – 10 GHz frequency span, 1 MHz IF bandwidth						
Number of points	201	401	1601	201	401	1601
Uncorrected	2.3	3.1	7.1	2.6	3.4	7.0
2-port calibration	3.4	4.8	13.1	3.9	5.4	12.7
4-port calibration	6.2	9.1	25.7	7.2	10.3	25.0
10 MHz – 20 GHz frequency span, 1 MHz IF bandwidth						
Number of points	201	401	1601	201	401	1601
Uncorrected	6.3	8.1	11.6	6.3	8.0	16.5
2-port calibration	11.6	15.2	22.3	11.6	15.0	32.1
4-port calibration	22.2	29.4	43.9	22.1	29.0	63.5
10 MHz – 44 GHz frequency span, 1 MHz IF bandwidth						
Number of points	201	401	1601	201	401	1601
Uncorrected	8.0	10.3	16.1	8.1	10.3	20.6
2-port calibration	15.0	19.5	31.2	15.1	19.5	40.3
4-port calibration	29.0	38.2	61.4	29.1	38.0	79.6

1. Analyzer display turned off with DISPLAY:VISible OFF. Measured with firmware revision A.17.05.06. Data for one trace (S11) measurement. Uncorrected measurements are for one sweep direction. 2-port calibration is measured with a 2-port option (Option 2N6). 4-port calibration is measured with a 4-port option (Option 4N6).

Table 70. Data Transfer Time, All Options (milliseconds) ¹ – Typical

Number of points	201	401	1601
SCPI over GPIB ²			
64-bit floating point	8.6	15.5	54.5
32-bit floating point	5.3	8.6	28.7
ASCII	33.3	65.0	254.5
SCPI over 1 Gbps LAN (Socket) ²			
REAL 64	1.5	1.5	1.9
REAL 32	1.7	1.6	1.7
ASCII	13.4	25.2	95.3
SCPI over 1 Gbps (HiSLIP) ²			
REAL 64	2.0	2.0	2.3
REAL 32	2.1	2.0	2.1
ASCII	2.8	4.0	8.7
SCPI over USB (SICL-USB) ²			
REAL 64	2.2	2.3	2.6
REAL 32	2.0	2.2	2.4

Number of points	201	401	1601
ASCII	2.5	3.3	8.4
SCPI over GPIB/USB (82357B)			
REAL 64	10.5	16.4	50.4
REAL 32	7.4	10.7	27.8
ASCII	140.0	280.1	1,120

1. Data transfer time varies depending on the type of PC and control software.
2. Transferred LogMag S11 data using :CALC:MEAS:DATA:FDAT?

Table 71. Cycle Time for Amplifier Noise Figure Measurement (with Option 0K1/0K2/0N1/0N2 and S96029B) (milliseconds)¹ – Typical

Conditions:

- Frequency range: 4 – 6 GHz
- IF bandwidth: 1 kHz
- Noise settings: 4 MHz noise bandwidth, 200 averages, low-noise receiver
- Impedance states for vector noise cal: 5
- Other: NA application display on; correction on

Description	51	101	201	401
Number of points	51	101	201	401
Scalar noise cal cycle time	1,134	2,230	4,424	8,811
Vector noise cal cycle time	5,238	10,337	20,533	40,926

1. Measured with firmware revision A.17.05.06.

Table 72. Cycle Time for Amplifier Gain Compression Measurement (with S96086B) (milliseconds)¹ – Typical

Conditions:

- Frequency range: 4 – 6 GHz
- IF bandwidth: 1 kHz
- Sweep type: Smart
- Compression type: 1 dB compression from linear gain (0.05 dB tolerance)
- Other: NA application display on; correction on

Description	51	101	201	401
Number of points	51	101	201	401
Cycle time	254	472	911	1,796

1. Measured with firmware revision A.17.05.06, iteration = 1.

Table 73. Cycle Time for Amplifier Swept Intermodulation Distortion Measurement (with S96087B) (milliseconds) ¹ – Typical

Conditions:

- Frequency range: 4 – 6 GHz
- Main tone IF bandwidth: 10 kHz
- IM tone IF bandwidth: 1 kHz
- Measurement parameters: PwrMain (avg), IM3 (dB relative to carrier)
- Other: NA application display on; correction on

Description				
Number of points	51	101	201	401
Cycle time	140	264	513	1,012

1. Measured using a 4-port E5081A, with firmware revision A.17.05.06.

Table 74. Cycle Time for Converter Noise Figure Measurement (with Option 0K1/0K2/0N1/0N2 and S96029B) (milliseconds) ¹ – Typical

Conditions:

- Input frequency: 3 GHz CF, 75 MHz span
- LO frequency: 2.12 GHz fixed
- Output frequency: 880 MHz CF, 75 MHz span
- IF bandwidth: 1 kHz
- Noise settings: 4 MHz noise bandwidth, 200 averages, low-noise receiver
- Impedance states for vector noise cal: 5
- Other: NA application display on; correction on

Description				
Number of points	51	101	201	401
Scalar noise cal cycle time	1,263	2,476	4,902	9,752
Vector noise cal cycle time	5,375	10,596	21,041	41,930

1. Measured using a 4-port E5081A, with firmware revision A.17.05.06.

Table 75. Cycle Time for Converter Measurement with SMC + Phase (with S96083B) (milliseconds) – Typical

Conditions:

- Input frequency: 3 GHz CF, 75 MHz span
- LO frequency: 2.12 GHz fixed
- Output frequency: 880 MHz CF, 75 MHz span
- Measurement parameter: SC21
- Other: NA application display on; correction on (includes match correction but not SC12 sweep)

Description

Number of points	51	101	201	401
Cycle time, 10 kHz IF bandwidth	72	98	149	250
Cycle time, 1 kHz IF bandwidth	205	362	671	1,292

1. Measured using a 4-port E5081A, with firmware revision A.17.05.06.

Table 76. Cycle Time for Converter Gain Compression Measurement (with S96086B) (milliseconds)¹ – Typical

Conditions:

- Input frequency: 3 GHz CF, 75 MHz span
- LO frequency: 2.12 GHz fixed
- Output frequency: 880 MHz CF, 75 MHz span
- IF bandwidth: 1 kHz
- Sweep type: Smart
- Compression type: 1 dB compression from linear gain (0.05 dB tolerance)
- Other: NA application display on; correction on

Description

Number of points	51	101	201	401
Cycle time	503	957	1,906	3,824

1. Measured using a 4-port E5081A, with firmware revision A.17.05.06, iteration = 1.

Table 77. Cycle Time for Converter Swept Intermodulation Distortion Measurement (with S96087B) (milliseconds)¹ – Typical

Conditions:

- Input frequency: 3 GHz CF, 75 MHz span
- LO frequency: 2.12 GHz fixed
- Output frequency: 880 MHz CF, 75 MHz span
- Main tone IF bandwidth: 10 kHz
- IM tone IF bandwidth: 1 kHz
- Measurement parameters: PwrMain (avg), IM3 (dB relative to carrier)
- Other: NA application display on; correction on

Description

Number of points	51	101	201	401
Cycle time	269	523	523	1,031

1. Measured using a 4-port E5081A, with firmware revision A.17.05.06.

Front-Panel Jumpers

ENA-X (Option 2N6/2N7/4N6/4N7) has the following front-panel jumpers for port 1 and 2.



Table 78. Frequency Range – Typical

Description	Typical
Upconverter BBnd In	100 kHz to 20 GHz
Upconverter RF Input (RF In)	100 kHz to 20 GHz
Upconverter RF Output (RF1 Out, RF2 Out)	100 kHz to 20 GHz (Option 2K6/4K6) 100 kHz to 44 GHz (Option 2N5/2N6/2N7/4N5/4N6/4N7)
Source Input (Src1 In, Src2 In)	100 kHz to 20 GHz (Option 2K5/2K6/4K5/4K6) 100 kHz to 44 GHz (Option 2N5/2N6/2N7/4N5/4N6/4N7)
IF Out (IF A Out, IF B Out, IF R1 Out, IF R2 Out)	100 kHz to 8.5 GHz

Table 79. Receiver Compression at Direct Receiver Access Input - Typical ¹

Description	Input Power at Test Port (dBm)	Magnitude (dB)	Phase (°)
100 kHz to 500 MHz	-3	0.15	1.5
500 MHz to 5 GHz	+5	0.15	1.5
5 GHz to 10 GHz	+8	0.15	1.5
10 GHz to 20 GHz	+5	0.15	1.5
20 GHz to 26.5 GHz	+11	0.15	1.5
26.5 GHz to 38 GHz	+8	0.15	1.5
38 GHz to 44 GHz	+1	0.15	1.5

1. Tested with receiver gain AUTO. (18 dB receiver attenuator is selected for measurements)

Table 80. Source Output

Frequency Resolution, Accuracy, Stability at Src1 Out and Src2 Out

Description	Specification	Typical
Frequency range	100 kHz to 20 GHz	
Frequency resolution	1 Hz	--
Frequency accuracy	± 7 ppm ± 0.45 ppm (Option 1E5)	--
Frequency stability	--	± 7 ppm ¹ ± 0.05 ppm (Option 1E5) ¹ ± 3 ppm/year maximum ² ± 0.1 ppm/year maximum (Option 1E5) ²

1. 0 to 40 °C. Assumes no variation in time.

2. Assumes no variation in temperature.

Maximum Leveled Output Power at Src1 Out and Src2 Out (dBm) - Typical

Description	Src1 Out	Src2 Out
100 kHz to 100 MHz	8	7
100 MHz to 500 MHz	7	6
500 MHz to 1 GHz	6	5
1 GHz to 6.13 GHz	5	2
6.13 GHz to 8.5 GHz	2	-2
8.5 GHz to 10 GHz	2	-3
10 GHz to 15 GHz	1	-3
15 GHz to 18 GHz	0	-5
18 GHz to 20 GHz	-1	-5

Power Level Accuracy at Src1 Out and Src2 Out (dB)¹ – Typical

Description	Typical
100 kHz to 1 MHz	± 0.4
1 MHz to 1 GHz	± 0.3
1 GHz to 5 GHz	± 0.4
5 GHz to 10 GHz	± 0.5
10 GHz to 15 GHz	± 0.7
15 GHz to 20 GHz	± 1.1

1. At reference power of -10 dBm, stepped sweep mode.

Power Level Linearity at Src1 Out and Src2 Out (dB)¹ – Typical

Description	Typical
100 kHz to 5 GHz	± 0.4
5 GHz to 20 GHz	± 0.5

1. Level linearity given is relative to -10 dBm, stepped sweep mode.
2. Swept sweep mode. $-60 \text{ dBm} \leq P \leq$ maximum typical power.
3. Stepped sweep mode. $-60 \text{ dBm} \leq P < -20 \text{ dBm}$.

Power Sweep Range Src1 Out and Src2 Out (dBm) – Typical

Description	Src1 Out	Src2 Out
100 kHz to 100 MHz	-60 to 8	-60 to 7
100 MHz to 500 MHz	-60 to 7	-60 to 6
500 MHz to 1 GHz	-60 to 6	-60 to 5
1 GHz to 6.13 GHz	-60 to 5	-60 to 2
6.13 GHz to 8.5 GHz	-60 to 2	-60 to -2
8.5 GHz to 10 GHz	-60 to 2	-60 to -3
10 GHz to 15 GHz	-60 to 1	-60 to -3
15 GHz to 18 GHz	-60 to 0	-60 to -5
18 GHz to 20 GHz	-60 to -1	-60 to -5

2nd Harmonics at Src1 Out and Src2 Out (dBc)¹ - Typical

Description	Typical
100 kHz to 10 MHz	-20
10 MHz to 500 MHz	-25
500 MHz to 20 GHz	-55

1. Listed frequency is fundamental frequency. Tested at maximum typical power or maximum leveled power.

3rd Harmonics at Src1 Out and Src2 Out (dBc)¹ - Typical

Description	Typical
100 kHz to 500 MHz	-22
500 MHz to 14.67 GHz	-63

1. Listed frequency is fundamental frequency. Tested at maximum typical power.

Non-harmonic Spurs at Src1 Out and Src2 Out (dBc)¹ - Typical

Description	Typical
100 kHz to 5 GHz	-60
5 GHz to 20 GHz	-40

1. Listed frequency is fundamental frequency. Tested at power of -10 dBm. Includes spurious related to LO signal and frac-N.

Table 81. Source Input and Test Port – Typical

Gain Between Source Input (Src1 In, Src2 In) and Test Port (dB)

Description	Amplified Path ¹	Thru Path
10 MHz to 200 MHz	3 to 9	-3 to 0
200 MHz to 1 GHz	3 to 9	-4 to -1
1 GHz to 3 GHz	1 to 9	-6 to -1.5
3 GHz to 5 GHz	1 to 7	-6 to -2.5
5 GHz to 8 GHz	1 to 7	-6.5 to -3
8 GHz to 10 GHz	-1 to 7	-7 to -3
10 GHz to 15 GHz	-2 to 6	-10 to -4
15 GHz to 20 GHz	-4 to 6	-11 to -5
20 GHz to 25 GHz	-6 to 4	-14 to -6
25 GHz to 30 GHz	-11 to 2	-16 to -8
30 GHz to 35 GHz	-11 to 0	-16 to -9
35 GHz to 37 GHz	-14 to 0	-18 to -10
37 GHz to 38 GHz	-14 to 0	-20 to -10
38 GHz to 40 GHz	-14 to -1	-20 to -10
40 GHz to 42 GHz	-23 to -2	-24 to -12
42 GHz to 44 GHz	-23 to -5	-24 to -12

1. Amplified with pre-amp, tested at -20 dBm.

Table 82. Upconverter RF Output – Typical

Maximum Output Power at Upconverter RF1 Out and Upconverter RF2 Out (dBm) - Typical

Description	Typical
10 MHz to 1 GHz	18.5
1 GHz to 3 GHz	20.0
3 GHz to 5 GHz	19.0
5 GHz to 7 GHz	18.0
7 GHz to 9 GHz	17.0
9 GHz to 10 GHz	16.0
10 GHz to 12 GHz	15.5
12 GHz to 13 GHz	14.5
13 GHz to 17 GHz	13.5
17 GHz to 20 GHz	12.5
20 GHz to 21 GHz	16.5
21 GHz to 22 GHz	15.5
22 GHz to 23.6 GHz	13.0
23.6 GHz to 24 GHz	13.5
24 GHz to 25 GHz	15.0
25 GHz to 27 GHz	16.0

Description	Typical
27 GHz to 28.2 GHz	16.5
28.2 GHz to 30 GHz	17.0
30 GHz to 31 GHz	16.5
31 GHz to 34 GHz	15.5
34 GHz to 35 GHz	15.0
35 GHz to 36 GHz	13.5
36 GHz to 39 GHz	12.0
39 GHz to 40 GHz	11.0
40 GHz to 41 GHz	9.5
41 GHz to 42 GHz	4.5
42 GHz to 44 GHz	2.0

1. Listed frequency is fundamental frequency. Tested at maximum typical power.

Table 83. IF Output - Typical

Output Power of IF Output (IF A Out, IF B Out, IF R1 Out, IF R2 Out)¹ (dBm) – Typical

Description	Typical
100 kHz to 1 MHz	-29 to -18
1 MHz to 30.6 MHz	-23 to -18
30.6 MHz to 500 MHz	-31 to -21
500 MHz to 5 GHz	-33 to -25
5 GHz to 10 GHz	-36 to -28
10 GHz to 20 GHz	-39 to -30
20 GHz to 25 GHz	-41 to -31
25 GHz to 34 GHz	-45 to -31
34 GHz to 40 GHz	-46 to -31
40 GHz to 44 GHz	-55 to -33

1. Listed frequency is fundamental (RF) frequency. RF frequency at Direct Receiver Access Input (Rcvr A In, Rcvr B In, Rcvr R1 In, or Rcvr R2 In) is fixed at power of -15 dBm.

Output Power of IF Output (IF A Out, IF B Out, IF R1 Out, IF R2 Out)¹ (dBm) – Typical

Description	Typical
30.6 MHz to 1 GHz	-34 to -29
1 GHz to 5 GHz	-37 to -30
5 GHz to 8 GHz	-40 to -31
8 GHz to 8.5 GHz	-41 to -32

1. Listed frequency is IF frequency. RF frequency at Direct Receiver Access Input (Rcvr A In, Rcvr B In, Rcvr R1 In, or Rcvr R2 In) is fixed to 5 GHz (E5081A Option 2K5/2K6/4K5/4K6) or 10 GHz (E5081A Option 2K5/2K6/4K5/4K6), at power of -15 dBm

Return Loss of IF Output (IF A Out, IF B Out, IF R1 Out, IF R2 Out)¹ (dB) – Typical

Description	Typical
10 MHz to 6 GHz	-8
6 GHz to 8 GHz	-6
8 GHz to 8.5 GHz	-2

Table 84. Damage level - Typical

Description	RF (dBm)	DC (V)
Rcvr A In, Rcvr B In, Rcvr R1 In, Rcvr R2 In	+27	± 35
Src1 In, Src2 In	+27	± 35
Upconverter RF In	+4	± 35
Upconverter BBnd In	+20	± 35
Upconverter RF1 Out, Upconverter RF2 Out	+26	± 35

Test Set Block Diagrams

Legend

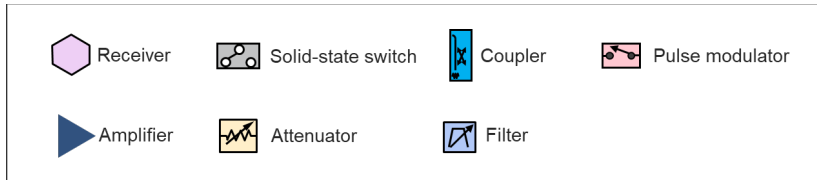

E5081A Option 2K5 (20 GHz, 2-port base without upconverter)

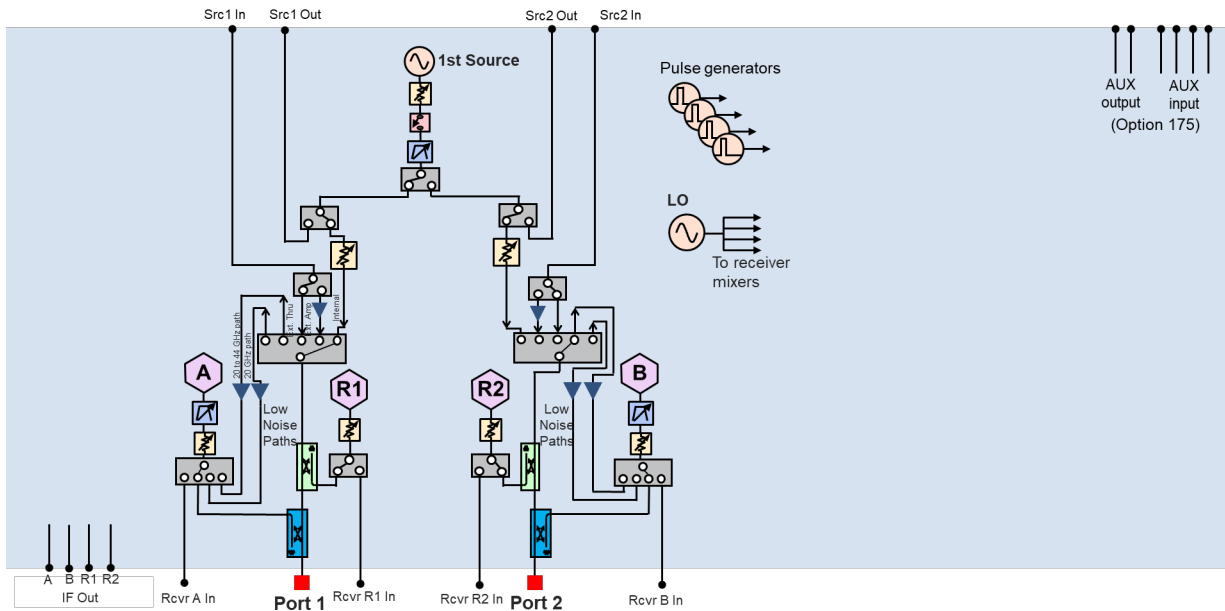

E5081A Option 4K5 (20 GHz, 4-port base without upconverter)

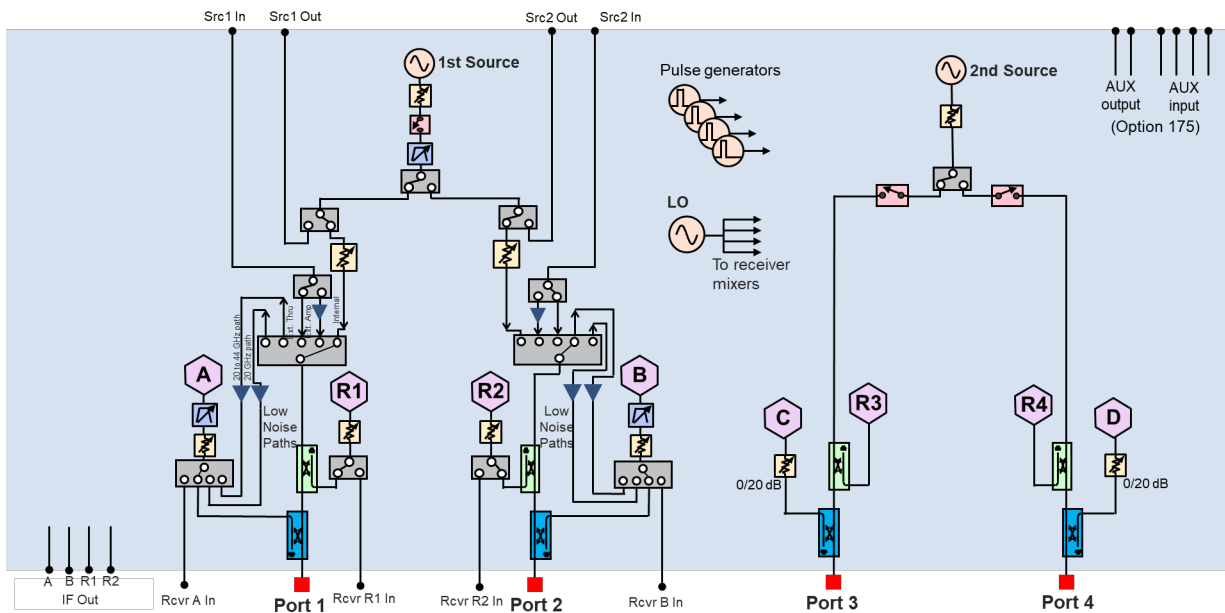

E5081A Option 2N5 (44 GHz, 2-port base without upconverter)

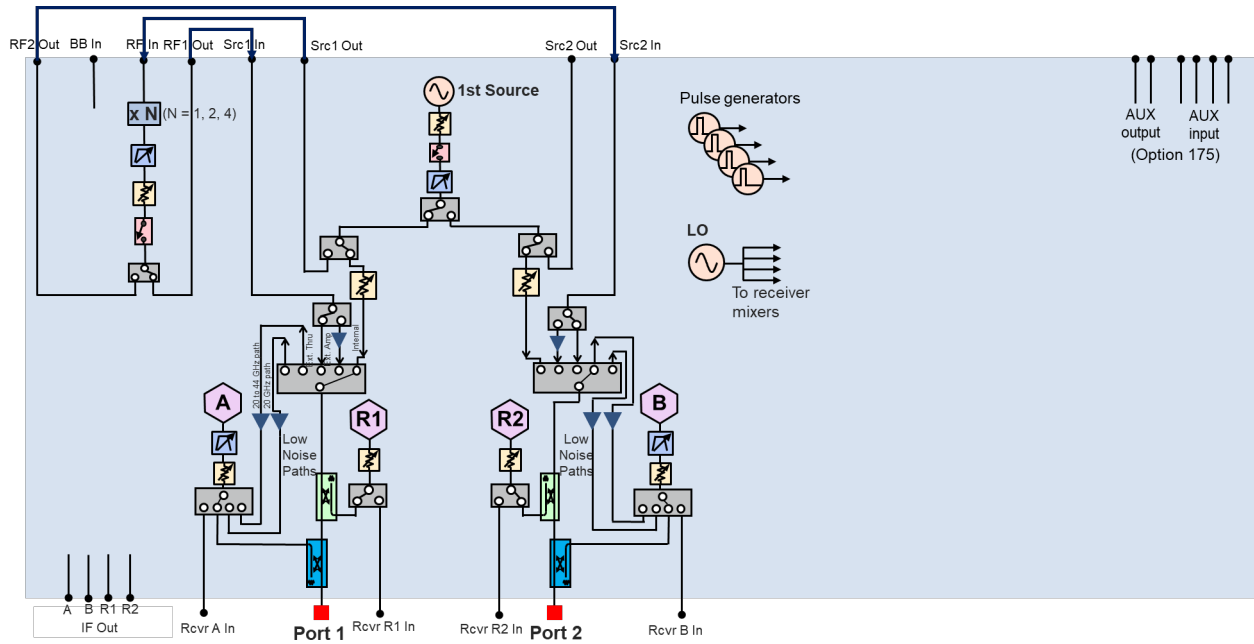

E5081A Option 4N5 (44 GHz, 4-port base without upconverter)

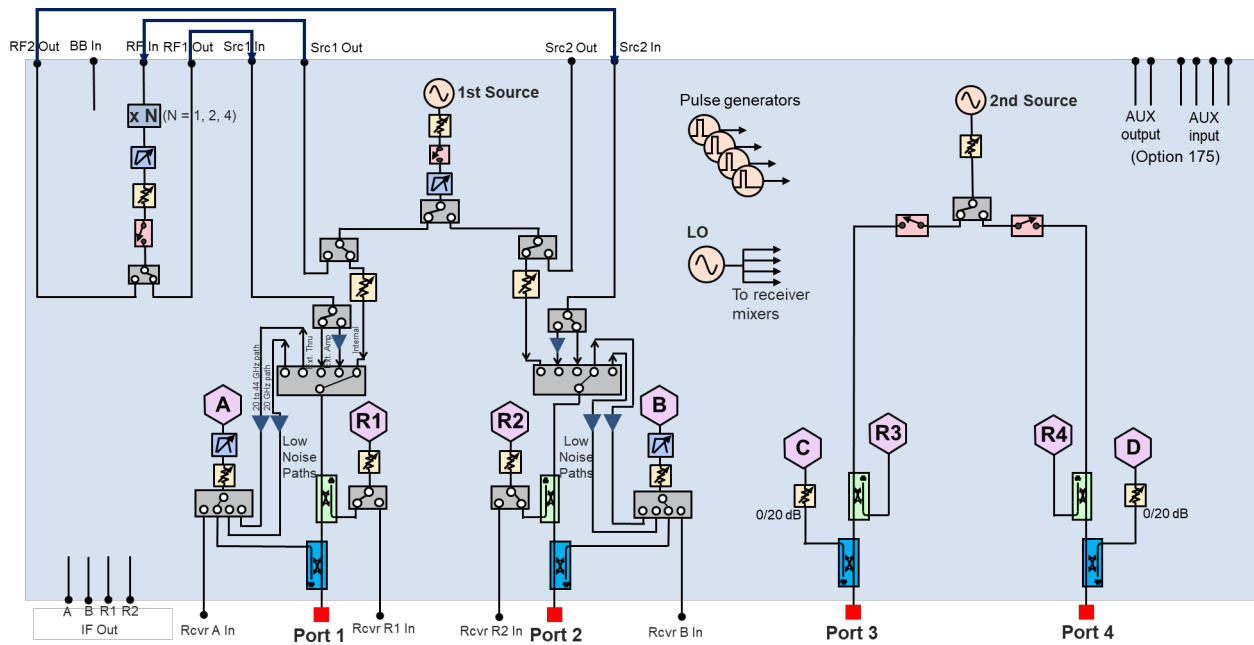

E5081A Option 2K6/2N6/2N7 (20 or 44 GHz, 2-port with upconverter)

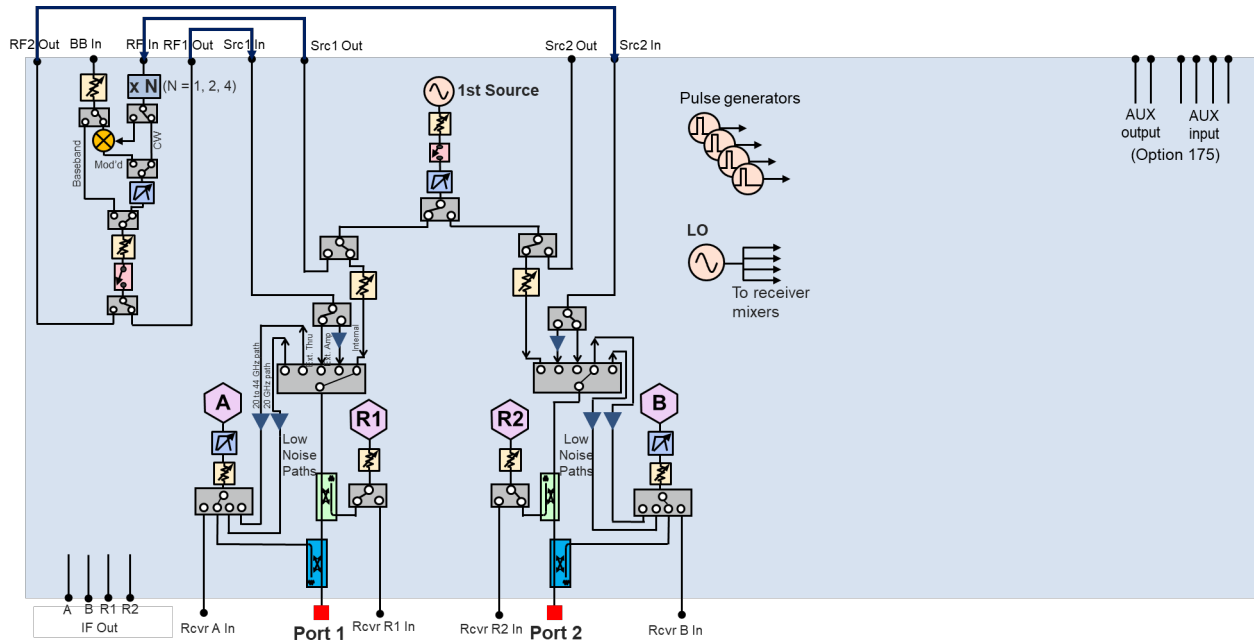

E5081A Option 4K6/4N6/4N7 (20 or 44 GHz, 4-port with upconverter)

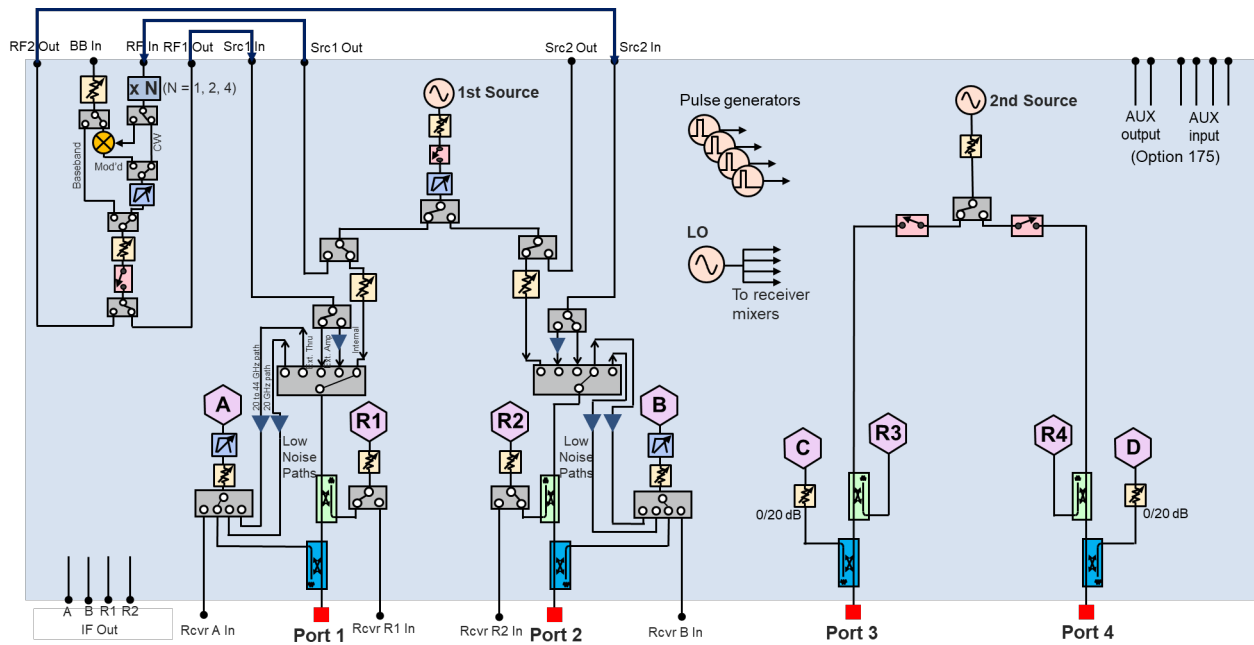

Receiver block diagram (port 1 and 2)

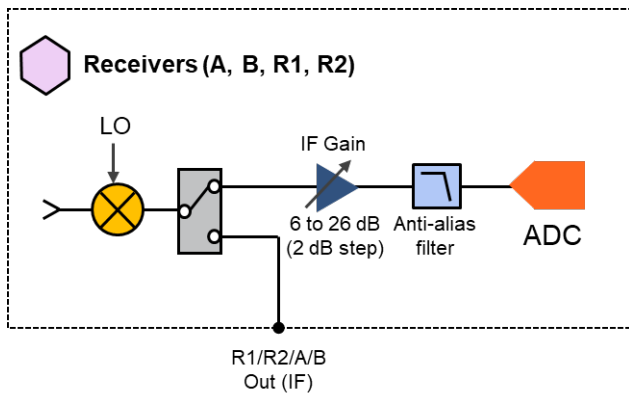

Literature Information

- ENA and ENA-X Vector Network Analyzer – Configuration Guide, [5992-3842EN](#)
- Keysight Network Analyzer – Selection Guide, [5989-7603EN](#)
- Use the Right Vector Network Analyzer for the Job – Product Fact Sheet, [3121-1316](#)
- Electronic Calibration (ECal) Modules for Network Analyzer – Technical Overview, [5963-3743E](#)

Web Resources

- Keysight Vector Network Analyzer Page - www.keysight.com/find/na
- Keysight ENA/ENA-X Vector Network Analyzer Page - www.keysight.com/find/ena
- Keysight Vector Network Analyzer Software Page - www.keysight.com/find/vnasoftware
- Keysight Electronic Calibration (ECal) Module Page - www.keysight.com/find/ecal

Confidently Covered by Keysight Services

Prevent delays caused by technical questions and reduce system downtime due to instrument maintenance and repairs with Keysight Services. Keysight Services are here to support your test needs with expert technical support, instrument repair and calibration, software support, training, alternative acquisition program options, and more.

A KeysightCare agreement provides dedicated, proactive support through a single point of contact for instruments, software, and solutions. KeysightCare covers an extensive group of instruments, application software, and solutions and ensures optimal uptime, faster response, faster access to experts, and faster resolution.

Keysight Services

Offering	Benefits
KeysightCare 	KeysightCare provides elevated support for Keysight instruments and software, with access to technical support experts who respond within a specified time and ensure committed repair and calibration turnaround times (TAT). KeysightCare offers multiple service agreement tiers, including KeysightCare Assured, Enhanced, and Application Software Support. See the KeysightCare data sheet for details.
KeysightCare Assured	KeysightCare Assured goes beyond basic warranty with repair services that include committed TAT and unlimited access to technical experts.
KeysightCare Enhanced	KeysightCare Enhanced includes all the benefits of KeysightCare Assured plus Keysight's accurate and reliable Calibration Services , accelerated, and committed TAT, and technical response.
Keysight Support Portal & Knowledge Center	All KeysightCare tiers include access to the Keysight Support Portal where you can manage support and service resources related to your assets such as service requests, and status, or browse the Knowledge Center.
Education Services	Build confidence and gain new skills to make accurate measurements, with flexible Education Services developed by Keysight experts. Including Start-up Assistance.
Alternative acquisition options	
KeysightAccess	Reduce budget challenges with a leased-based subscription service, that offers low monthly payments, enabling you to get the instruments, software, and technical support you want for your test needs.

Recommended services

Maximize your test system up-time by securing technical support, repair, and calibration services with committed response and turnaround times. 1-year KeysightCare Assured is included in every new instrument purchase. Obtain multi-year KeysightCare upfront to eliminate the need for lengthy and tedious paperwork and yearly requests for maintenance budget. Plus, you benefit from secured service for 2, 3, or 5 years.

Service	Function
KeysightCare Enhanced*	Includes tech support, warranty and calibration
R-55B-001-1	KeysightCare Enhanced – Upgrade 1 year
R-55B-001-2	KeysightCare Enhanced – Extend to 2 years
R-55B-001-3	KeysightCare Enhanced – Extend to 3 years (Recommended)
R-55B-001-5	KeysightCare Enhanced – Extend to 5 years (Recommended)
KeysightCare Assured	Includes tech support and warranty
R-55A-001-2	KeysightCare Assured – Extend to 2 years
R-55A-001-3	KeysightCare Assured – Extend to 3 years
R-55A-001-5	KeysightCare Assured – Extend to 5 years
Start-Up Assistance	
PS-S40-01	Included – instrument fundamentals and operations starter
PS-S40-04	Recommended – instrument fundamentals and operations starter
PS-S40-02	Optional, technology & measurement science standard learning

* Available in select countries. For details, please view the [datasheet](#). R-55B-001-2/3/5 must be ordered with R-55B-001-1.